

Service
Service
Service



Service Manual



TABLE OF CONTENTS

	Chapter
Location of PCB Boards	1-2
Versions Variation	1-2
Specifications	1-3
Measurement Setup	1-6
Service Aids	1-7
ESD & Safety Instruction	1-8
Lead-free Soldering Information	1-9
Setting Procedure & Repair Instructions	2
Disassembly Instructions & Service Positions	3
Block & Wiring Diagram	4
MAIN+VFD+SUB+USB+MP3+SENSOR+BT Board	5
BD Board.....	6
Touch Board	7
Power Board(Subwoofer)	8
Mechanical Exploded View	9
Revision List	10

© Copyright 2013 Philips Consumer Electronics B.V. Eindhoven, The Netherlands
 All rights reserved. No part of this publication may be reproduced, stored in a retrieval system or transmitted, in any form or by any means, electronic, mechanical, photocopying, or otherwise without the prior permission of Philips.

Published by SL_HF1305 Service Audio Printed in The Netherlands Subject to modification

GB 3141 785 39441

Version 1.1



PHILIPS

LOCATION OF PCB BOARDS

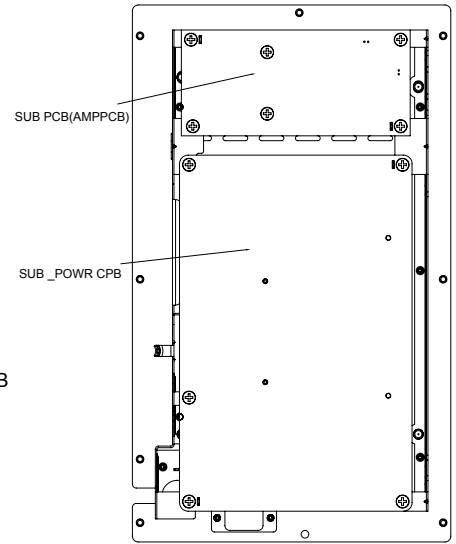
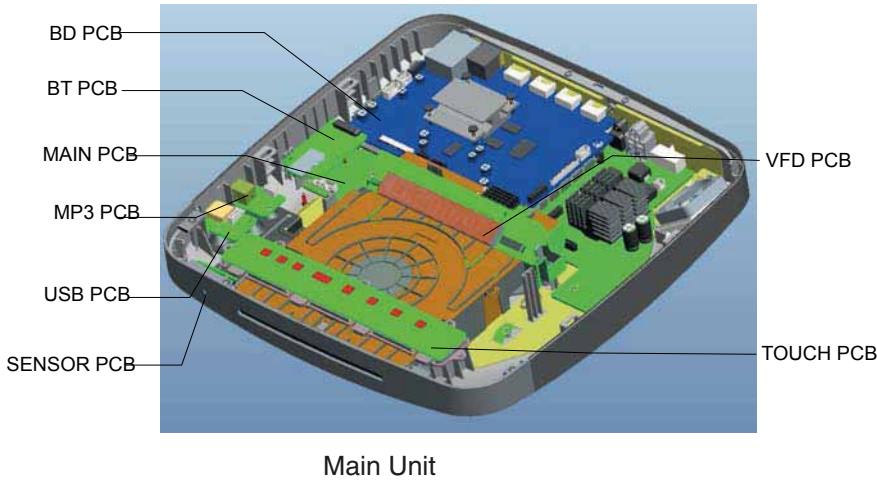

Subwoofer

VERSION VARIATION:

Type/Versions	HTB7250D	HTB7255D
	/12	/12
Features		
Output Power - 500W	X	X
Voltage (220~240V)	X	X
Bluetooth	X	X
Subwoofer	X	X

SERVICE SCENARIO MATRIX:

Type/Versions	HTD7250D	HTD7255D
	/12	/12
Board in used		
MAIN+VFD+SUB+USB+MP3+SENSOR+BT Board	C	C
Power Board(subwoofer)	C	C
BD Board	Bd	Bd
Touch Board	Bd	Bd

*Bd= Board Level Replacement

*C = Component Level Repair

SPECIFICATIONS

Region codes

The type plate on the back or bottom of the home theater shows which regions it supports.

Country	DVD	BD
Europe, United Kingdom	 	
Asia Pacific, Taiwan, Korea	 	
Latin America	 	
Australia, New Zealand	 	
Russia, India	 	
China	 	

Media formats

- AVCHD, BD, BD-R/ BD-RE, BD-Video, DVD-Video, DVD+R/+RW, DVD-R/-RW, DVD+R/-R DL, CD-R/CD-RW, Audio CD, Video CD/SVCD, Picture files, MP3 media, WMA media, DivX Plus HD media, USB storage device

File formats

- Audio:
 - .aac, .mka, .mp3, .wma, .wav, .mp4, .m4a, .flac, .ogg
 - .ra (Available only in Asia Pacific and China)
- Video:
 - .avi, .divx, .mp4, .m4v, .mkv, .m2ts, .mpg, .mpeg, .flv, .3gp
 - .asf, .wmv, .rmvb, .rm, .rv (Available only in Asia Pacific and China)
- Picture: .jpg, .jpeg, .jpe, .jfif, .gif, .png

Audio formats

Your home theater supports the following audio files.

Extension	Con- tainer	Audio codec	Bit rate
.mp3	MP3	MP3	Upto 320 kbps
.wma	ASF	WMA WMA Pro	Upto 192 kbps Upto 768 kbps
.aac	AAC	AAC, HE- AAC	Upto 192 kbps
.wav	WAV	PCM	27.648 Mbps
.m4a	MKV	AAC	192 kbps
.mka	MKA	PCM	27.648 Mbps
		Dolby Digital	640 kbps
		DTS core	1.54 Mbps
		MPEG	912 kbps
		MP3	Upto 320 kbps
		WMA	Upto 192 kbps
		WMA Pro	Upto 768 kbps
		AAC, HE- AAC	Upto 192 kbps
.ra	RM	AAC, HE- AAC	Upto 192 kbps
		Cook	96469 bps
.flac	FLAC	FLAC	Upto 24 bps
.ogg	OGG	Vorbis	Variable bit rate, maximum block size 4096

Extension	Con- tainer	Audio codec	Bit rate
		FLAC	Upto 24 bps
		OGGPCM	No limit
		MP3	Upto 320 kbps

Video formats

If you have a high definition TV, your home theater allows you to play your:

- video files with a resolution of 1920 × 1080 pixels (except DivX, which has a resolution of 77220 × 576) and frame rate of 6 ~ 30 frames per second.
- photo files with a resolution of 18 M pixels.

.avi files in AVI container

Audio codec	Video codec	Bit rate
PCM, Dolby Digital, DTS core, MP3, WMA	DivX 3.11, DivX 4.x, DivX 5.x, DivX 6.x	10 Mbps max
	MPEG 1, MPEG 2	40 Mbps
	MPEG 4 SP / ASP	38.4 Mbps
	H.264/AVC upto HiP@5.1	25 Mbps
	WMV9	45 Mbps

.divx files in AVI container

Audio codec	Video codec	Bit rate
PCM, Dolby Digital, MP3, WMA	DivX 3.11, DivX 4.x, DivX 5.x, DivX 6.x	10 Mbps max

.mp4 or .m4v files in MP4 container

Audio codec	Video codec	Bit rate
Dolby Digital, MPEG, MP3, AAC, HE-AAC, DD+	MPEG 1, MPEG 2	40 Mbps
	MPEG 4 ASP	38.4 Mbps
	H.264/AVC HiP@5.1	25 Mbps

.mkv files in MKV container

Audio codec	Video codec	Bit rate
PCM, Dolby Digital, DTS core, MPEG, MP3, WMA, AAC, HE-AAC, DD+	DivX Plus HD	30 Mbps
	MPEG 1, MPEG 2	40 Mbps
	MPEG 4 ASP	38.4 Mbps
	H.264/AVC HiP@5.1	25 Mbps
	WMV9	45 Mbps

.m2ts files in MKV container

Audio codec	Video codec	Bit rate
PCM, Dolby Digital, DTS core, MPEG, MP3, WMA, AAC, HE-AAC, DD+	MPEG 1, MPEG 2	40 Mbps
	MPEG 4 ASP	38.4 Mbps
	H.264/AVC HiP@5.1	25 Mbps
	WMV9	45 Mbps

.asf and .wmv files in ASF container (Available only in Asia Pacific and China)

Audio codec	Video codec	Bit rate
Dolby Digital, MP3, WMA, DD+	MPEG 4 ASP	38.4 Mbps
	H.264/AVC HiP@5.1	25 Mbps
	WMV9	45 Mbps

.mpg and .mpeg files in PS container

Audio codec	Video codec	Bit rate
PCM, DTS core, MPEG, MP3	MPEG 1, MPEG 2	40 Mbps

.flv files in FLV container

Audio codec	Video codec	Bit rate
MP3, AAC	H.264/AVC upto HiP@5.1	25 Mbps
	H.263	38.4 Mbps
	On2 VP6	40 Mbps

.3gp files in 3GP container

Audio codec	Video codec	Bit rate
AAC, HE-AAC	MPEG 4 ASP	38.4 Mbps
	H.264/AVC upto HiP@5.1	25 Mbps max

.rm, .rv, and .rmvb files in RM container (Available only in Asia Pacific and China)

Audio codec	Video codec	Bit rate
AAC, COOK	RV30, RV40	40 Mbps

Amplifier

- Total output power: 500W RMS (+/- 0.5 dB, 30% THD) / 400W RMS (+/- 0.5 dB, 10% THD)
- Frequency response: 20 Hz-20 kHz / ± 3 dB
- Signal-to-noise ratio: > 65 dB (CCIR) / (A-weighted)
- Input sensitivity:
 - AUX: 650 mV
 - AUDIO-IN: 300 mV

Video

- Signal system: PAL / NTSC
- HDMI output: 480i/576i, 480p/576p, 720p, 1080i, 1080p, 1080p24

Audio

- S/PDIF Digital audio input:
 - Optical: TOSLINK
- Sampling frequency:
 - MP3: 32 kHz, 44.1 kHz, 48 kHz
 - WMA: 44.1 kHz, 48 kHz
- Constant bit rate:
 - MP3: 32 kbps - 320 kbps
 - WMA: 48 kbps - 192 kbps

Radio

- Tuning range:
 - Europe/Russia/China: FM 87.5-108 MHz (50 kHz)
 - Asia Pacific/Latin America: FM 87.5-108 MHz (50/100 kHz)
- Signal-to-noise ratio: FM 50 dB
- Frequency response: FM 180 Hz-12.5 kHz / ± 3 dB

USB

- Compatibility: Hi-Speed USB (2.0)
- Class support: USB Mass Storage Class (MSC)
- File system: FAT16, FAT32, NTFS

Main unit

- Dimensions (WxHxD): 304.4 x 68.8 x 307.2 mm
- Weight: 2.4 kg

Subwoofer

- Power supply:
 - Europe/China: 220-240V~, 50 Hz
 - Latin America/Asia Pacific: 110-127 V/220-240V~, 50/60 Hz
 - Russia/India: 220-240V~, 50 Hz
- Power consumption: 110 W
- Standby power consumption: ≤ 0.5 W
- Impedance: 3 ohm
- Speaker drivers: 165 mm (6.5") woofer
- Frequency response: 20 Hz-150 Hz
- Dimensions (WxHxD): 204 x 394 x 345 mm
- Weight: 6.1 kg

Speakers

- Output power: 2 x 135W RMS (30% THD)
- Speaker impedance: 5 ohm
- Speaker drivers: 2 x 76.2 mm (3") woofer + 1 x 25.4 mm (1") tweeter
- Frequency response: 150 Hz-20 kHz
- Dimensions (WxHxD): 97 x 301 x 120 mm
- Weight: 1.45 kg/each

Remote control batteries

- 2 x AAA-R03-1.5 V

Laser

- Laser Type (Diode): InGaN/AlGaIn (BD), AlGaInP (DVD/CD)
- Wave length: 405 +7 nm/-7 nm (BD), 655 +10 nm/-10 nm (DVD), 790 +10 nm/-20 nm (CD)
- Output power (Max. ratings): 20 mW (BD), 6 mW (DVD), 7 mW (CD)

Specifications subject to change without prior notice.

MEASUREMENT SETUP

Tuner FM

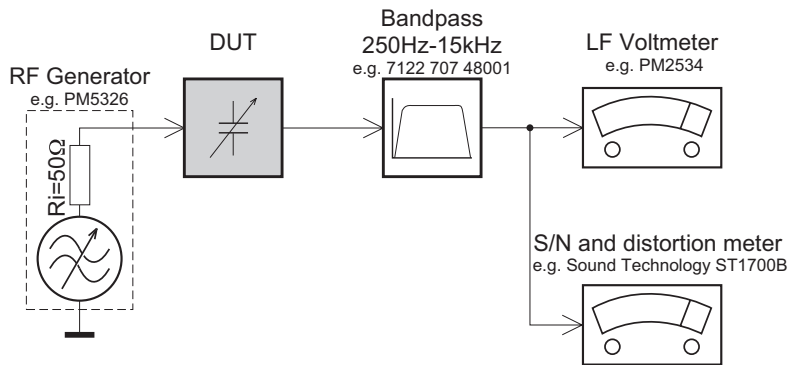

Use a bandpass filter to eliminate hum (50Hz, 100Hz) and disturbance from the pilotone (19kHz, 38kHz).

CD

Use Audio Signal Disc SBC429 4822 397 30184
(replaces test disc 3)

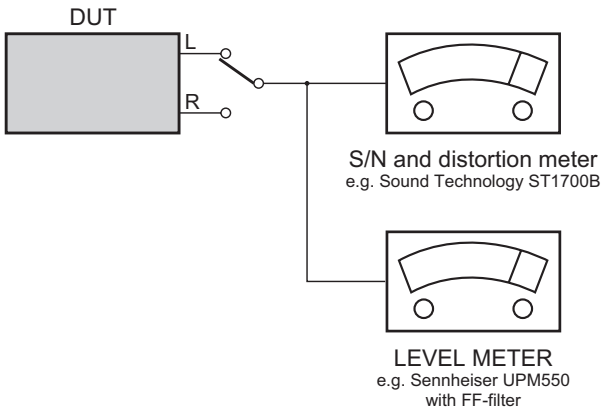

SERVICE AIDS

Service Tools:

Universal Torx driver holder	4822 395 91019
Torx bit T10 150mm	4822 395 50456
Torx driver set T6-T20	4822 395 50145
Torx driver T10 extended	4822 395 50423

Compact Disc:

SBC426/426A Test disc 5 + 5A	4822 397 30096
SBC442 Audio Burn-in test disc 1kHz	4822 397 30155
SBC429 Audio Signals disc	4822 397 30184
Dolby Pro-logic Test Disc	4822 395 10216

HANDLING CHIP COMPONENTS

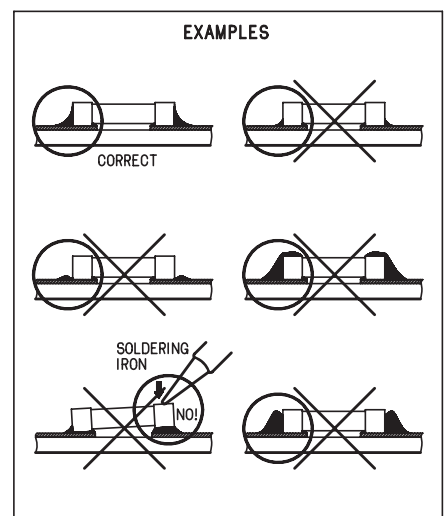
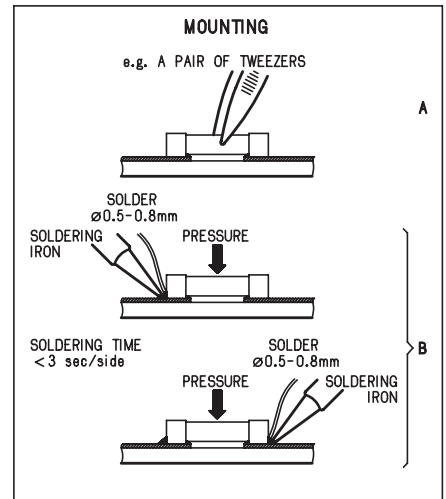
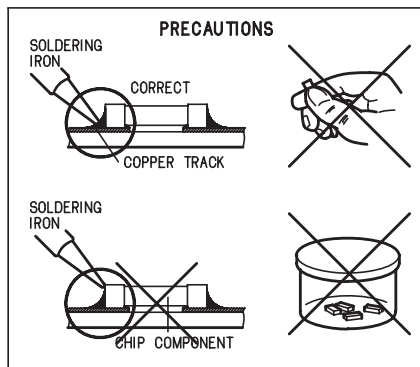
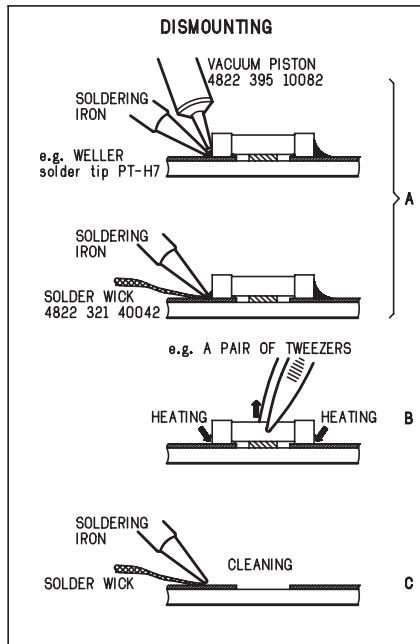
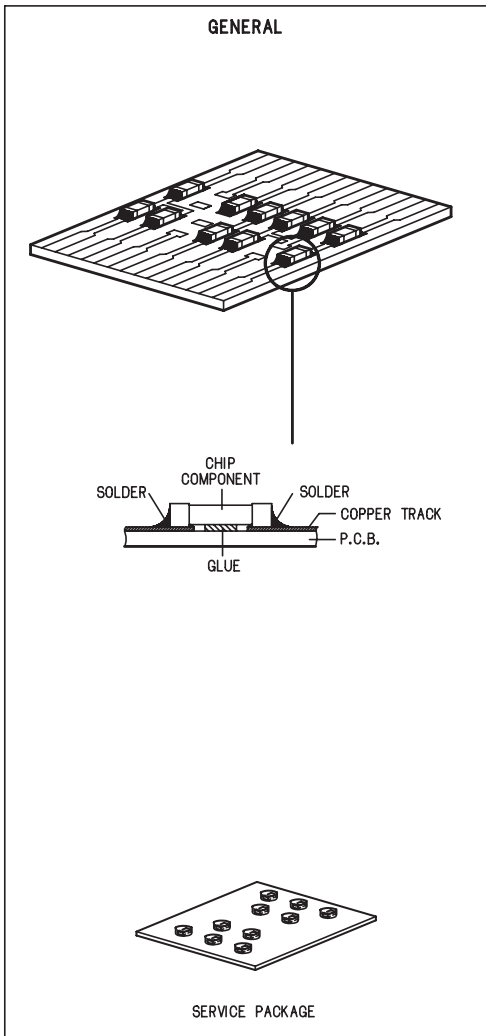

ESD**GB WARNING**

All ICs and many other semi-conductors are susceptible to electrostatic discharges (ESD). Careless handling during repair can reduce life drastically.

When repairing, make sure that you are connected with the same potential as the mass of the set via a wrist wrap with resistance. Keep components and tools also at this potential.

F ATTENTION

Tous les IC et beaucoup d'autres semi-conducteurs sont sensibles aux décharges statiques (ESD).

Leur longévité pourrait être considérablement écourtée par le fait qu'aucune précaution n'est prise à leur manipulation.

Lors de réparations, s'assurer de bien être relié au même potentiel que la masse de l'appareil et enfilez le bracelet serti d'une résistance de sécurité.

Veiller à ce que les composants ainsi que les outils que l'on utilise soient également à ce potentiel.

D WARNUNG

Alle ICs und viele andere Halbleiter sind empfindlich gegenüber elektrostatischen Entladungen (ESD).

Unsorgfältige Behandlung im Reparaturfall kann die Lebensdauer drastisch reduzieren. Veranlassen Sie, dass Sie im Reparaturfall über ein Pulsarmband mit Widerstand verbunden sind mit dem gleichen Potential wie die Masse des Gerätes. Bauteile und Hilfsmittel auch auf dieses gleiche Potential halten.

NL WAARSCHUWING

Alle IC's en vele andere halfgeleiders zijn gevoelig voor electrostatische ontladingen (ESD).

Onzorgvuldig behandelen tijdens reparatie kan de levensduur drastisch doen verminderen. Zorg ervoor dat u tijdens reparatie via een polsband met weerstand verbonden bent met hetzelfde potentiaal als de massa van het apparaat.

Houd componenten en hulpmiddelen ook op ditzelfde potentiaal.

I AVVERTIMENTO

Tutti IC e parecchi semi-conduttori sono sensibili alle scariche statiche (ESD).

La loro longevità potrebbe essere fortemente ridotta in caso di non osservazione della più grande cauzione alla loro manipolazione. Durante le riparazioni occorre quindi essere collegato allo stesso potenziale che quello della massa dell'apparecchio tramite un braccialetto a resistenza.

Assicurarsi che i componenti e anche gli utensili con quali si lavora siano anche a questo potenziale.

GB ESD PROTECTION EQUIPMENT

Complete Kit ESD3 (small tablemat, wristband, connection box, estention cable and earth cable 4822 310 10671
Wristband tester 4822 344 13999

GB

Safety regulations require that the set be restored to its original condition and that parts which are identical with those specified, be used.

Safety components are marked by the symbol Δ .

NL

Veiligheidsbepalingen vereisen, dat het apparaat bij reparatie in zijn oorspronkelijke toestand wordt teruggebracht en dat onderdelen, identiek aan de gespecificeerde, worden toegepast.

De Veiligheidsonderdelen zijn aangeduid met het symbol Δ .

F

Les normes de sécurité exigent que l'appareil soit remis à l'état d'origine et que soient utilisés les pièces de rechange identiques à celles spécifiées.

Less composants de sécurité sont marqués Δ .

D

Bei jeder Reparatur sind die geltenden Sicherheitsvorschriften zu beachten. Der Originalzustand des Geräts darf nicht verändert werden; für Reparaturen sind Original-Ersatzteile zu verwenden.

Sicherheitsbauteile sind durch das Symbol Δ markiert.

I

Le norme di sicurezza esigono che l'apparecchio venga rimesso nelle condizioni originali e che siano utilizzati i pezzi di ricambio identici a quelli specificati.

Componenti di sicurezza sono marcati con Δ .

GB

After servicing and before returning set to customer perform a leakage current measurement test from all exposed metal parts to earth ground to assure no shock hazard exist, The leakage current must not exceed 0.5mA.

**GB Warning !**

Invisible laser radiation when open.
Avoid direct exposure to beam.

S Varning !

Osynlig laserstrålning när apparaten är öppnad och spårren är urkopplad. Betrakta ej strålen.

SF Varoitus !

Avatussa laitteessa ja suojalukituksen ohitettaessa olet alttiina näkymättömälle laserisäteilylle. Älä katso säteeseen!

DK Advarsel !

Usynlig laserstrålning ved åbning når sikkerhedsafbrydere er ude af funktion. Undgå udsættelse for strålning.

F

"Pour votre sécurité, ces documents doivent être utilisés par des spécialistes agréés, seuls habilités à réparer votre appareil en panne".

Pb(Lead) Free Solder

When soldering, be sure to use the pb free solder.

IDENTIFICATION:

Regardless of special logo (not always indicated)



one must treat all sets from **1 Jan 2005** onwards, according next rules:

Important note: In fact also products of year 2004 must be treated in this way as long as you avoid mixing solder-alloys (leaded/ lead-free). So best to always use SAC305 and the higher temperatures belong to this.

Due to lead-free technology some rules have to be respected by the workshop during a repair:

- Use only lead-free solder alloy Philips SAC305 with order code 0622 149 00106. If lead-free solder-paste is required, please contact the manufacturer of your solder-equipment. In general use of solder-paste within workshops should be avoided because paste is not easy to store and to handle.
- Use only adequate solder tools applicable for lead-free solder alloy. The solder tool must be able
 - To reach at least a solder-temperature of 400°C,
 - To stabilize the adjusted temperature at the solder-tip
 - To exchange solder-tips for different applications.
- Adjust your solder tool so that a temperature around 360°C – 380°C is reached and stabilized at the solder joint. Heating-time of the solder-joint should not exceed ~ 4 sec. Avoid temperatures above 400°C otherwise wear-out of tips will rise drastically and flux-fluid will be destroyed. To avoid wear-out of tips switch off unused equipment, or reduce heat.
- Mix of lead-free solder alloy / parts with leaded solder alloy / parts is possible but PHILIPS recommends strongly to avoid mixed solder alloy types (leaded and lead-free).
If one cannot avoid or does not know whether product is lead-free, clean carefully the solder-joint from old solder alloy and re-solder with new solder alloy (SAC305).
- Use only original spare-parts listed in the Service-Manuals. Not listed standard-material (commodities) has to be purchased at external companies.
- Special information for BGA-ICs:
 - Always use the 12nc-recognizable soldering temperature profile of the specific BGA (for desoldering always use the lead-free temperature profile, in case of doubt)
 - Lead free BGA-ICs will be delivered in so-called 'dry-packaging' (sealed pack including a silica gel pack) to protect the IC against moisture. After opening,

dependent of MSL-level seen on indicator-label in the bag, the BGA-IC possibly still has to be baked dry. (MSL=Moisture Sensitivity Level). This will be communicated via AYS-website.

Do not re-use BGAs at all.

- For sets produced before 1.1.2005 (except products of 2004), containing leaded solder-alloy and components, all needed spare-parts will be available till the end of the service-period. For repair of such sets nothing changes.
- On our website www.atyourservice.ce.Philips.com you find more information to:
 - BGA-de-/soldering (+ baking instructions)
 - Heating-profiles of BGAs and other ICs used in Philips-sets

You will find this and more technical information within the "magazine", chapter "workshop news".

For additional questions please contact your local repair-helpdesk.

Software upgrade & Procedure to restore product setting

1) Restore factory setting

- Press “” <Home> button on R/C.
- Select <SETUP>, then press “OK” button on R/C.
- Select <Advanced>.
- Select <Restore default settings>, then press <OK> to confirm.

2) Password change

- Press “” <Home> button on R/C.
 - Select <SETUP>, then press “OK” button on R/C.
 - Select <preference>.
 - Select <Change Password> <Confirm>, then press <OK> button on R/C.
- “0000” is default password supplied.

3) Trade mode

- In open model, press “” <Home> button on R/C.
- Press “2” “5” “9” on R/C, VFD will display “TRA ON” or “TRA OFF”.

4) Check software version

- Press “” <Home> button on R/C
- Select <Setup>, then press <OK> button on R/C.
- Select <Advanced Setup> <Version information>, then press <OK> button on R/C.
- TV will show message as follow:

```

Model:HTB7250D/12
Versions
  System SW:X.XX.XXX
  Subsystem SW:XX-XX-XX-XX
Wireless(Wi-Fi):XX:XX:XX:XX:XX:XX
Extended unique Identifier(EUI64):0025d1ffef3c15
PRODUCT ID:A5UDJSCREQVGS5
For information,frequently asked questions and
software updates,please visit
www.philips.com/support
  
```

Close

- press <OK> button to exit .

5) Upgrading new software

Method 1: Update software from a USB storage device

- Create a folder named “UPG” in your USB storage device, and Copy the latest upgrading software into the folder.
- Connect the USB storage device to the home theater.
- Press “” <Home> button on R/C, and select <Setup>.
- Select <Advanced> <Software Update> <USB>.
- Follow the onscreen instructions to confirm the update.
 - »» Update process takes about 5 minutes to complete.
 - »» Once complete, the home theater automatically switches off and restarts.If it does not, disconnect the powercord for a few seconds and then reconnect it.

Method 2: Update software from the internet

Note: To check for new updates, compare the current software version of your home theater with the latest software version (if available) on the Philips web site, and for BD-Live application and software update, make sure that the network router has access to the Internet and the firewall is disabled.

- The “LAN” jack at the back panel of the set must be connect to the network router via network cable and the set connect to TV, Prepare the connection as shown follow:

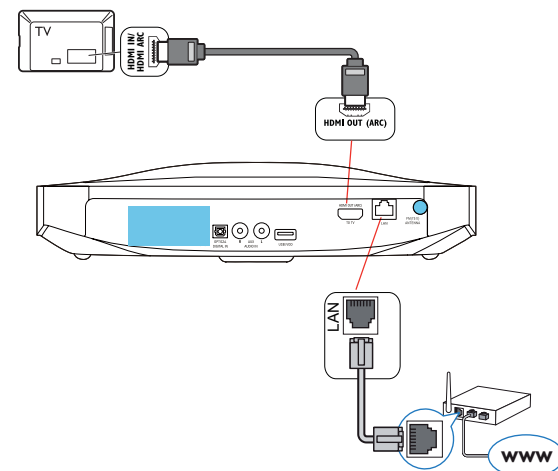

- Press “” <Home> button on R/C, and select <Setup>.
- Select <Advanced> <Software Update> <Network>.
- If an upgrade media is detected, you are prompted to start or cancel the update.
 - »» Downloading of the upgrading file maytake long, depending on your home network condition.
- Follow the onscreen instructions to confirm the update.
 - »» Update process takes about 5 minutes to complete.
 - »» Once complete, the home theater automatically switches off and restarts.If it does not, disconnect the powercord for a few seconds and then reconnect it.

6) How to replace the defective Blu-ray Loader

- Remove the defective Blu-ray Loader.
- Remove the shield cover at the top of Blu-ray Loader as shown below:
 - Loosen 5 screws on the top of Blu-ray Loader as shown in figure1

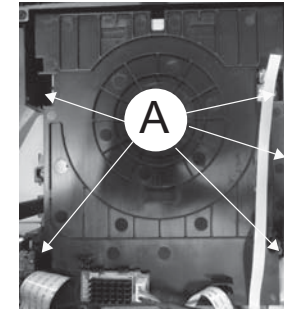
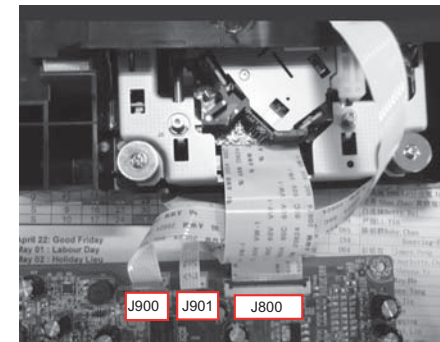
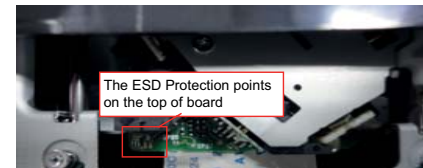

Figure 1

- Assembly Blu-ray Loader to “J800”,”J900”,”J901” on the top of BD Board as shown below.



- Remove soldered joint on the ESD protection points.



Bottom side view of OPU

- Note: The ESD protection points must be soldered if
- o the Blu-ray Loader is OK and needs to be disconnected from connector J800, J900 and J901 of the BD Board.
 - o the defective Blu-ray Loader is needed to be send back to supplier for failure analysis and to support backcharging evidence.

7) Update the onscreen help

If the current version of the onscreen help is lower than the latest version available on www.philips.com/support, download and install the latest onscreen help.

* A USB flash drive that is FAT or NTFS formatted, with at least 35MB of memory. Do not use a USB hard drive.

* A computer with internet access.

* An archive utility that supports the ZIP file format

- Connect a USB flash drive to your computer.
- In your web browser, go to www.philips.com/support.
- At the philips support website, find your product and click on User manuals, and then locate the User Manual Upgrade Software. (The help update is available as a zip file).

- Save the zip file in the root directory of your USB flash drive.

- Use the archive utility to extract the help update file in the root directory. (A file named “HTSXXXXeDFU.zip” is extracted under the UPG folder of your USB flash drive, “xxxx” being the model number of your home theater.)

- Disconnect the USB flash drive from your computer.

Caution: Do not switch off the home theater or remove the USB flash drive during the update.

- Connect the USB flash drive containing the downloaded file to your home theater. (Make sure that no disc is loaded inside the disc compartment)

- Press “” <Home> button on R/C.

- Enter 338 on the remote control.

- Follow the onscreen instructions to confirm the update.

- Disconnect the USB flash drive from the home theater.

CAUTION!

This information is confidential and may not be distributed.Only a qualified service person should reprogram the Region Code.

HTB7225/9225 REPAIR CHART

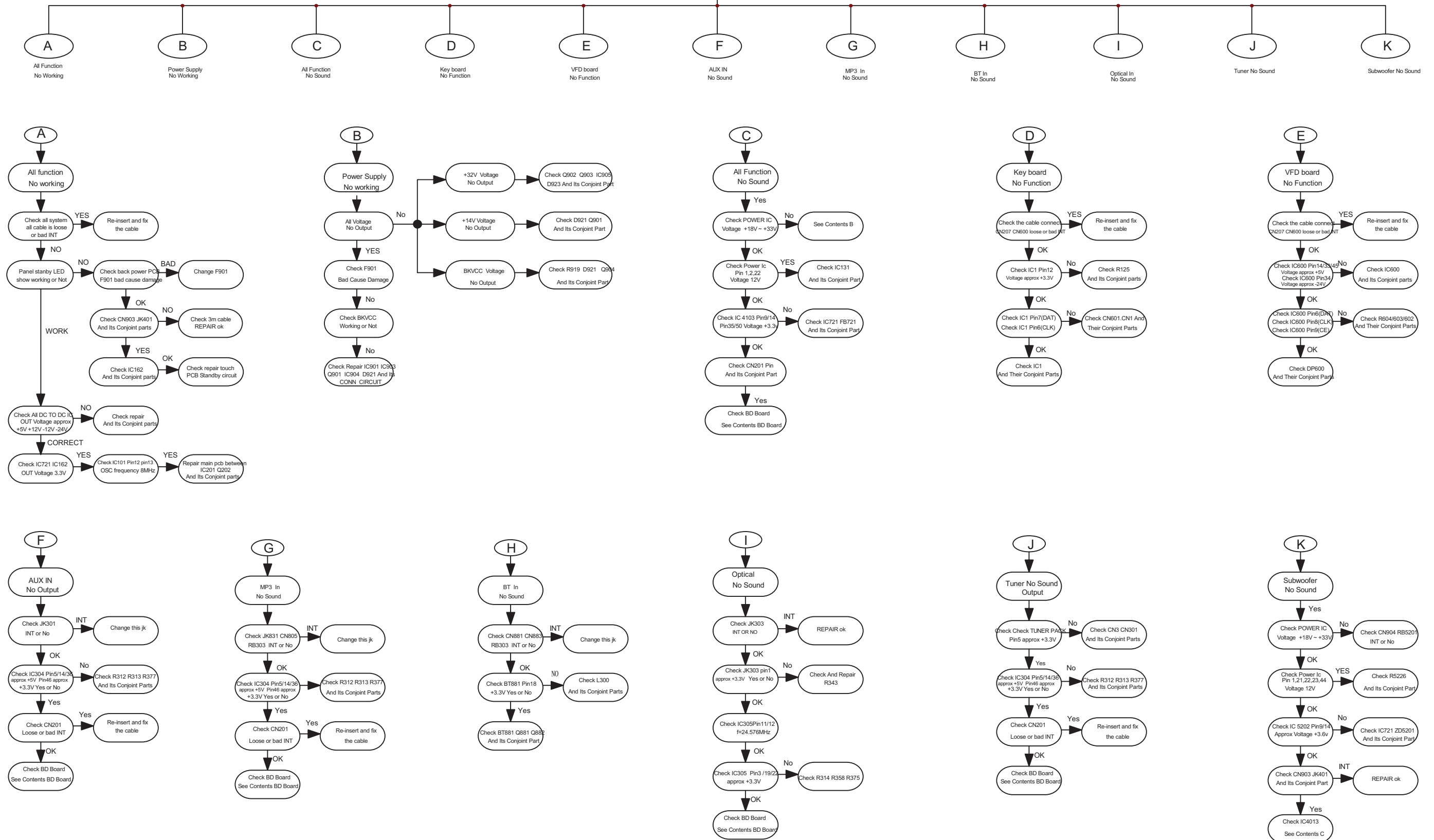

BD Board REPAIR CHART

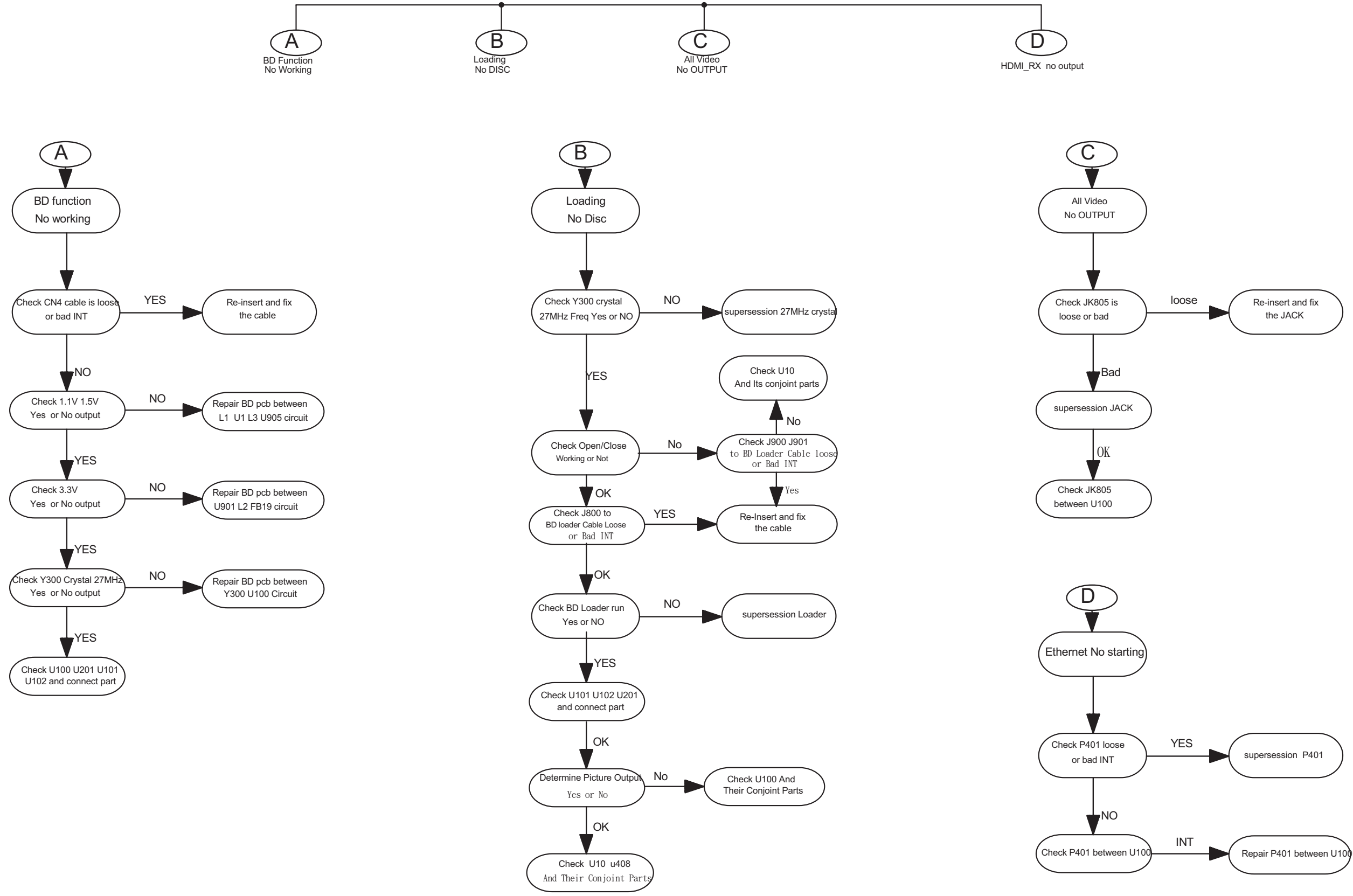

3 - 1
DISASSEMBLY INSTRUCTIONS-MAIN UNIT

Note: In some service positions the components or copper patterns of one board may risk touching its neighbouring pc boards or metallic parts. To prevent such short-circuit use a piece of hard paper or other insulating material between them.

Dismantling of the Top Cover

- 1) Loosen 1 screw "A" at the back panel to remove the top cover as shown in figure 1.

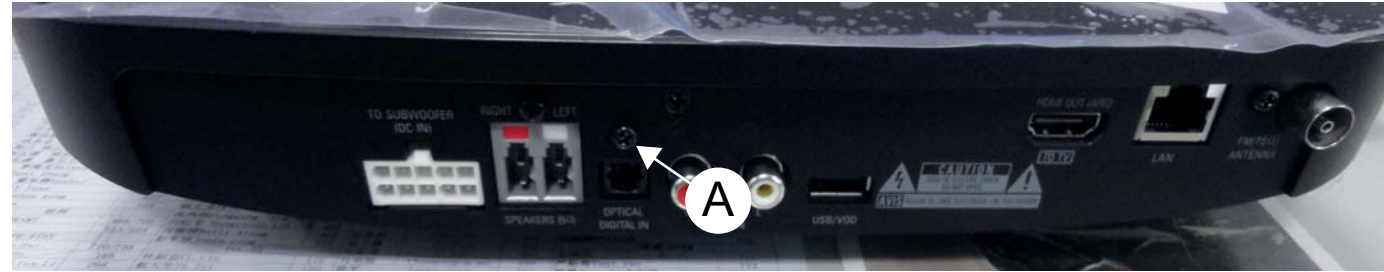

Figure 1

Dismantling of the BT Board

- 1) Loosen 2 screws "B" on the top of BT board as shown in figure 2.

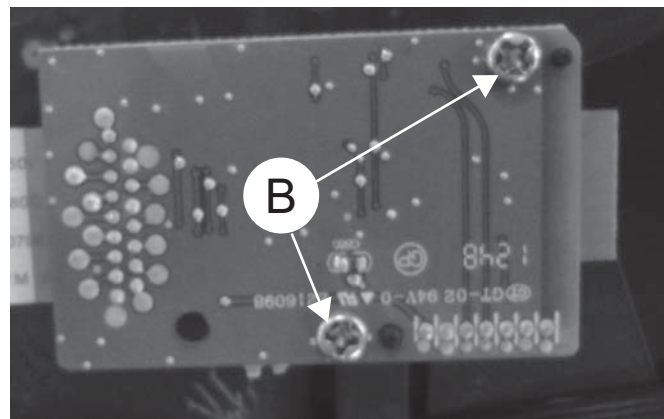

Figure 2

Dismantling of the TOUCH Board

- 1) Loosen 3 screws "C" at the bracket of Touch Board as shown in figure.

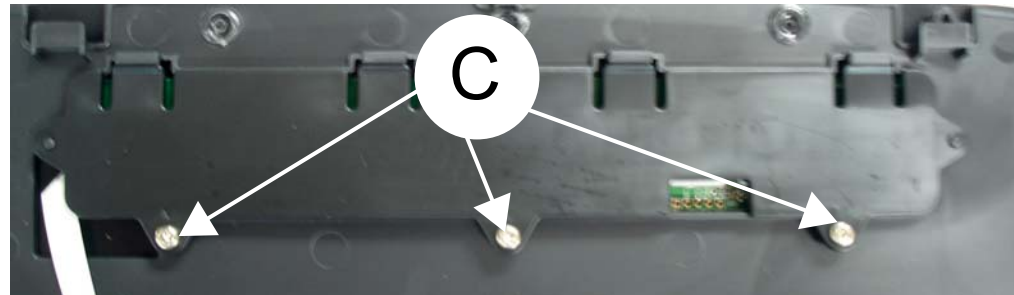

Figure 3

3 - 1
Dismantling of the VFD Board

- 1) Loosen 1 screws "D" on the top of VFD Board as shown in figure 4.

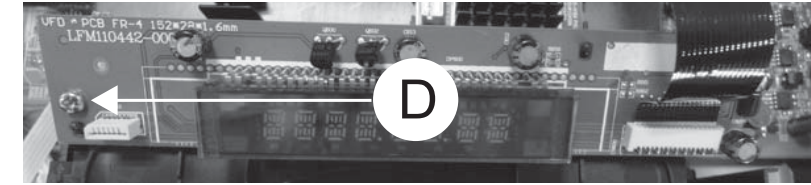

Figure 4

Dismantling of the DVD Module

- 1) Loosen 5 screws "E" at the DVD Module as shown in figure 5.

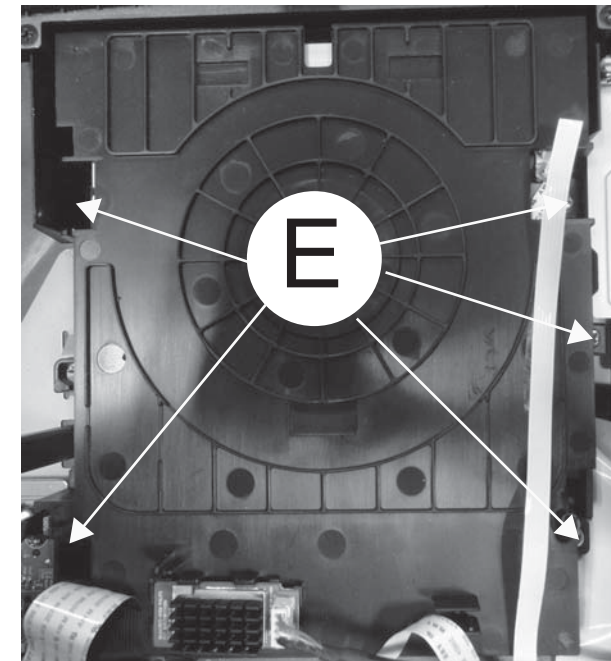

Figure 5

Dismantling of the MP3 & USB & SENSOR Board

- 1) Loosen 3 screws "F" on the top of MP3&USB Board as shown in figure 6.
- 2) Loosen 2 screws "G" on the top of SENSOR Board as shown in figure 7.

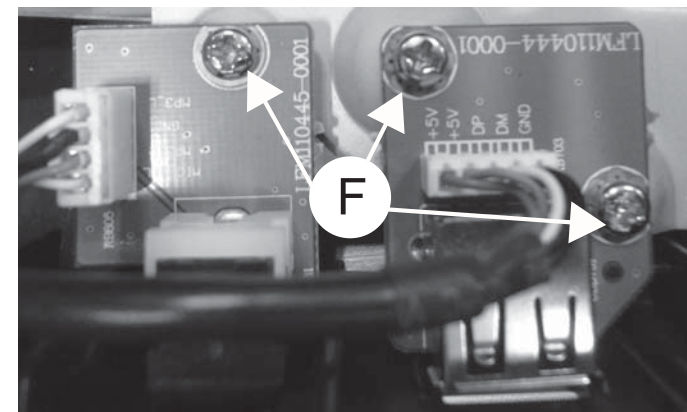

Figure 6

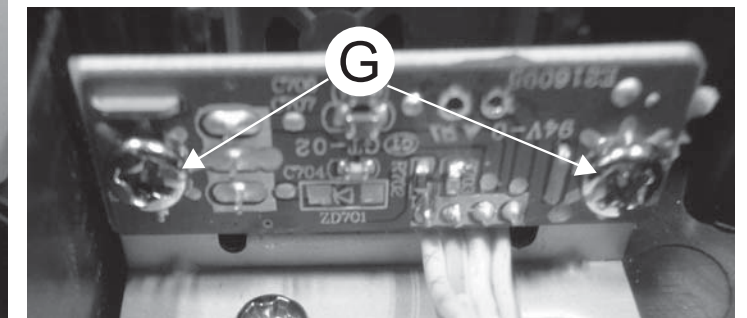

Figure 7

Dismantling of the BD Board

- 1) Loosen 4 screws "H" on the top of BD Board as shown in figure 8.
- 2) Loosen 1 screw "I" at the back panel as shown in figure 9.

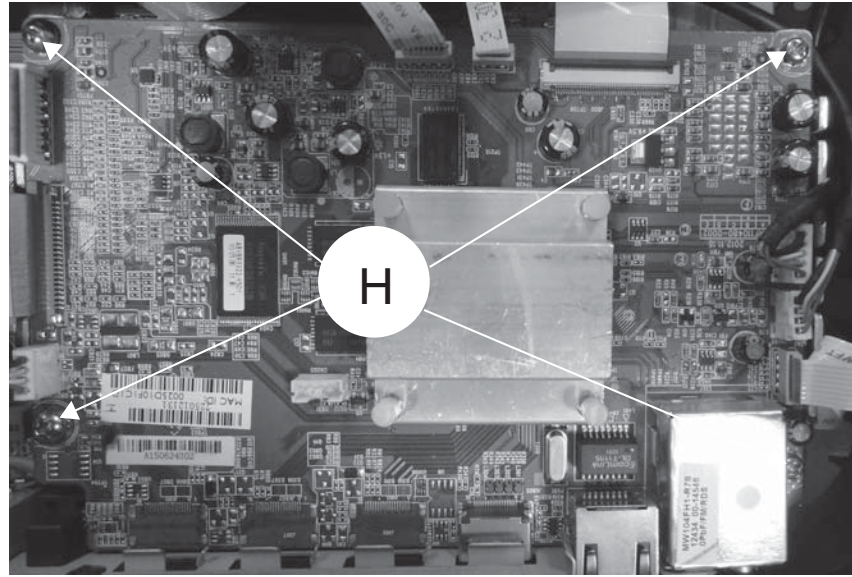

Figure 8



Figure 9

Dismantling of the MAIN Board

- 1) Loosen 6 screws "J" on the top of main board as shown in figure 10.
- 2) Loosen 2 screws "K" at the back panel as shown in figure 11

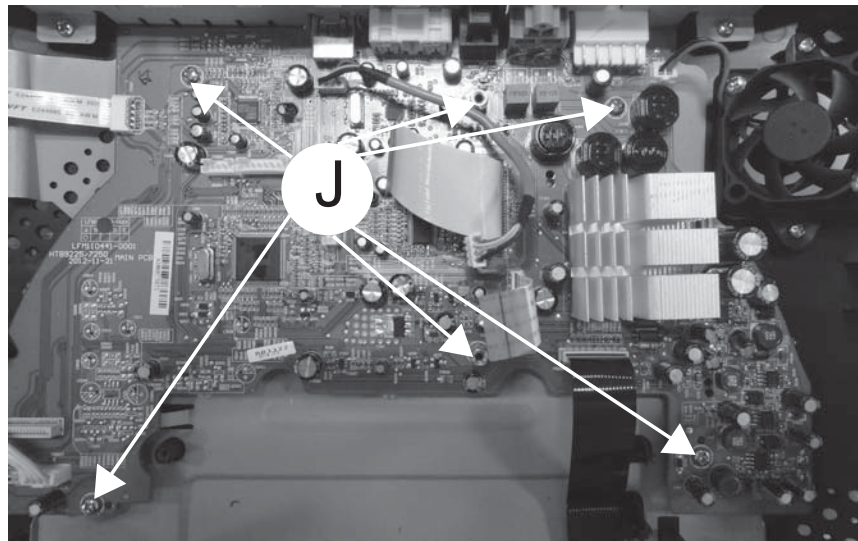
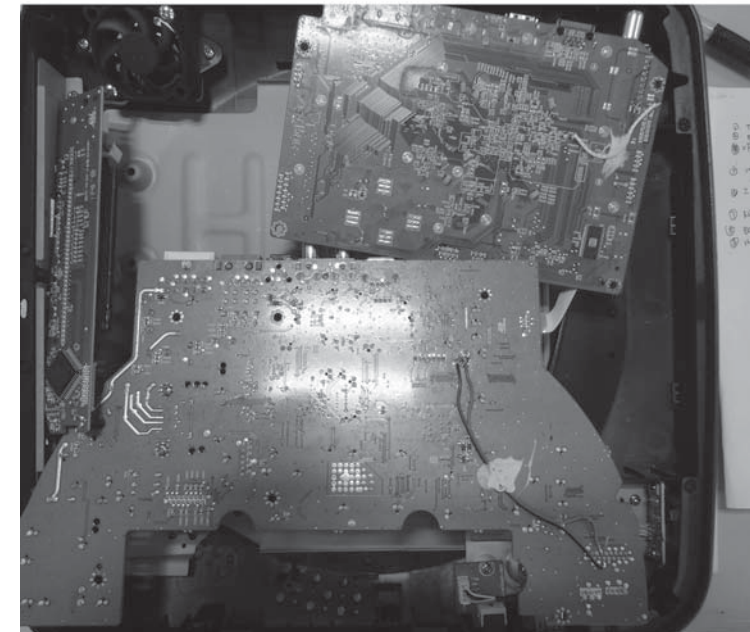
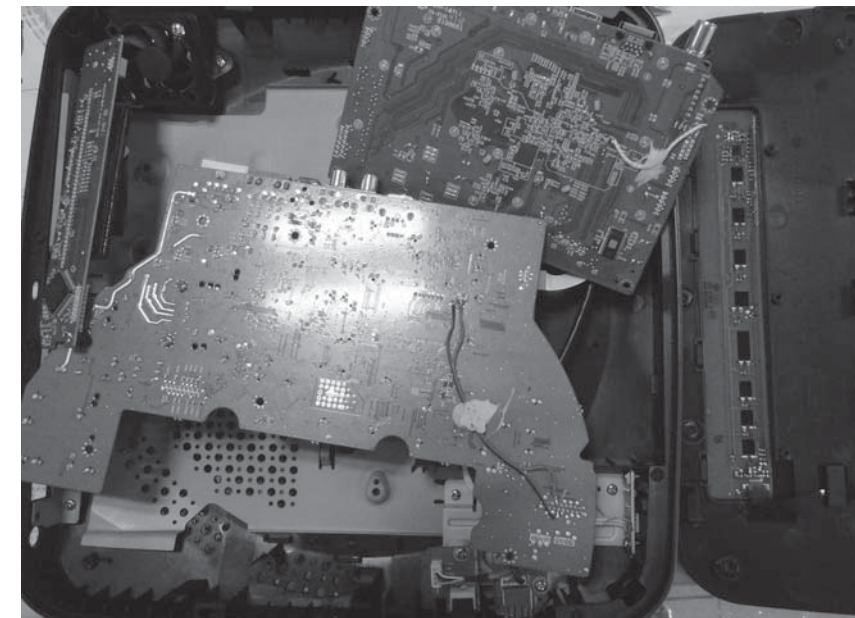

Figure 10



Figure 11

SERVICE POSITIONS (MAIN UNIT)**Service Position A - MAIN&BD Board****Service Position E - All Boards**

DISASSEMBLY INSTRUCTIONS-SUBWOOFER

Dismantling of the Subwoofer Rear Panel

1) Loosen 9 screws "Q" at the subwoofer rear panel as shown in figure 17.

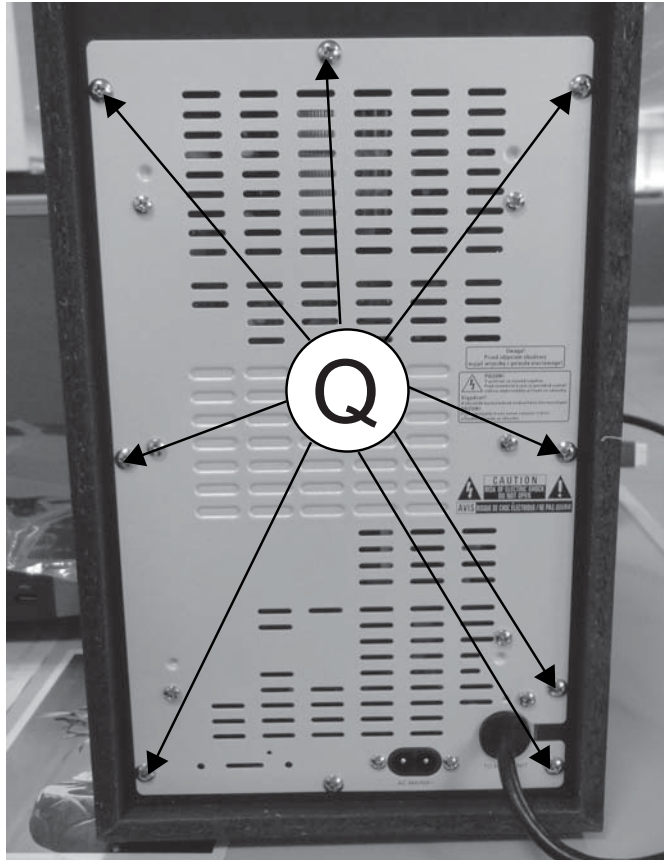

Figure 17

Dismantling of the Power Board

1) Loosen 5 screws "R" on the top of power board as shown in figure 18.

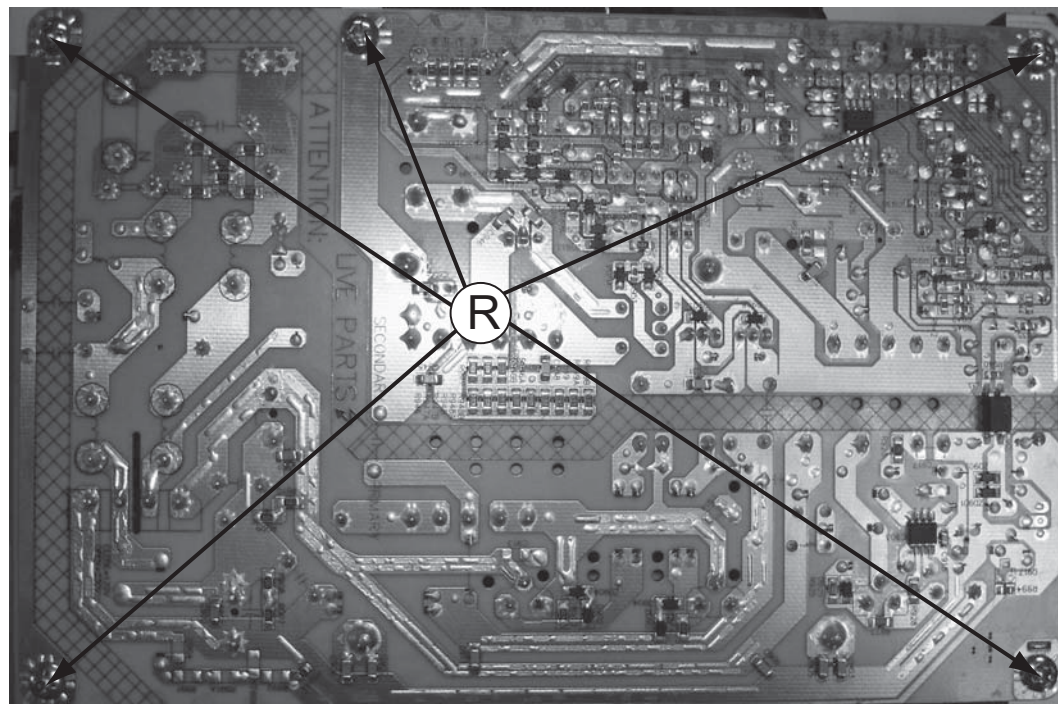

Figure 18

Dismantling of the Subwoofer AMP Board

1) Loosen 4 screws "S" on the top of subwoofer AMP board as shown in figure 19.

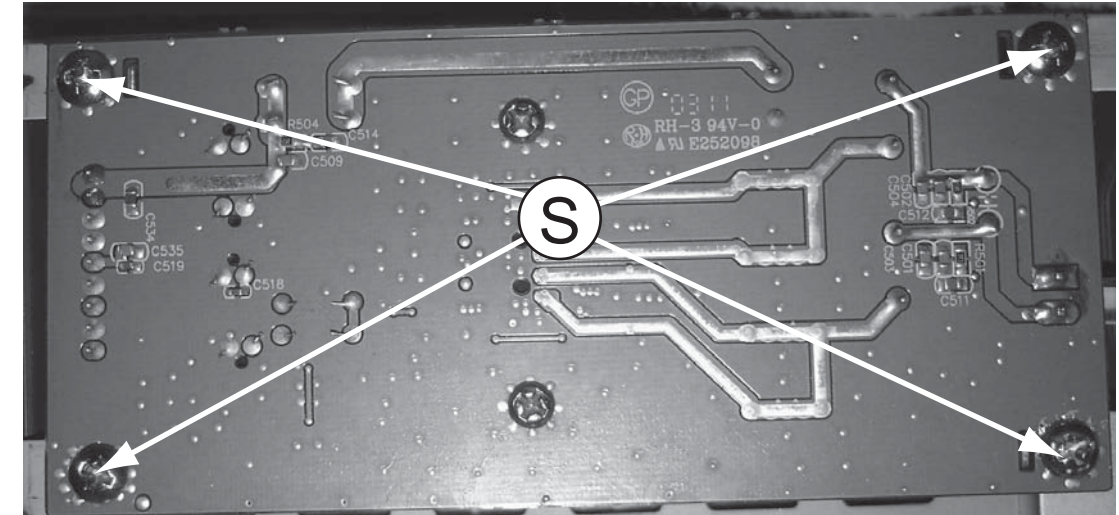
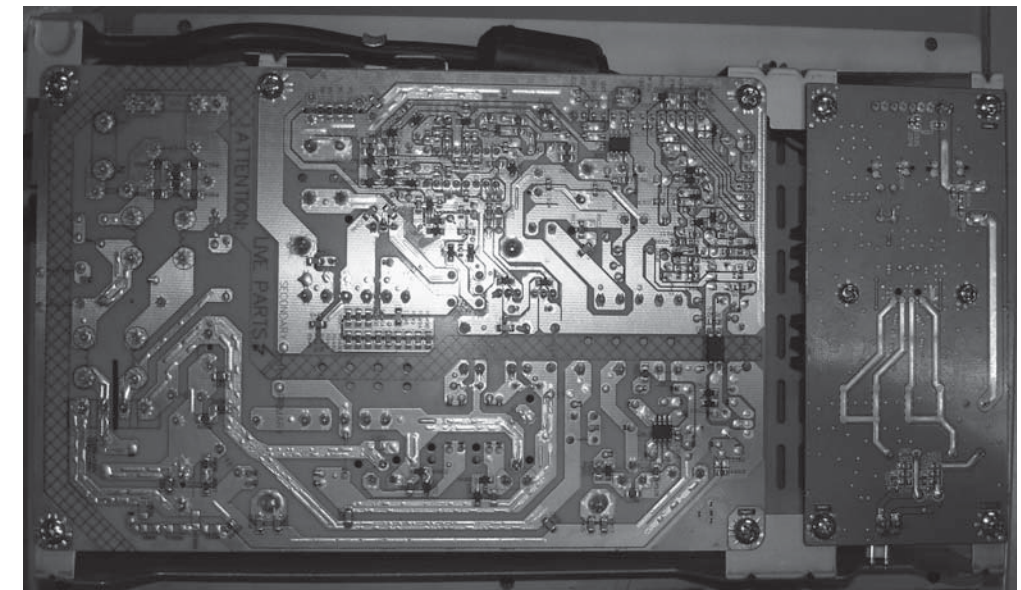

Figure 19

SERVICE POSITIONS (SUBWOOFER)



3 - 1
DISASSEMBLY INSTRUCTIONS-MAIN UNIT

Note: In some service positions the components or copper patterns of one board may risk touching its neighbouring pc boards or metallic parts. To prevent such short-circuit use a piece of hard paper or other insulating material between them.

Dismantling of the Top Cover

- 1) Loosen 1 screw "A" at the back panel to remove the top cover as shown in figure 1.

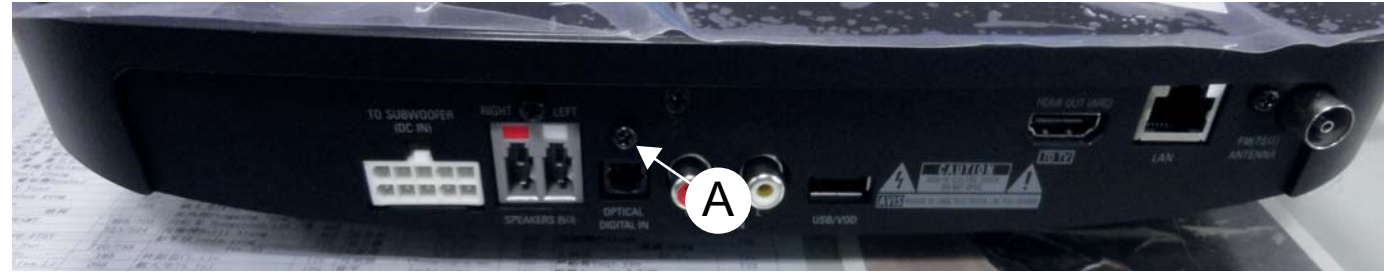

Figure 1

Dismantling of the BT Board

- 1) Loosen 2 screws "B" on the top of BT board as shown in figure 2.

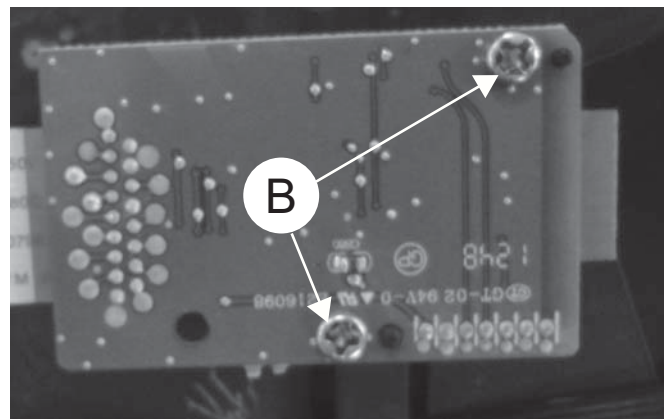

Figure 2

Dismantling of the TOUCH Board

- 1) Loosen 3 screws "C" at the bracket of Touch Board as shown in figure.

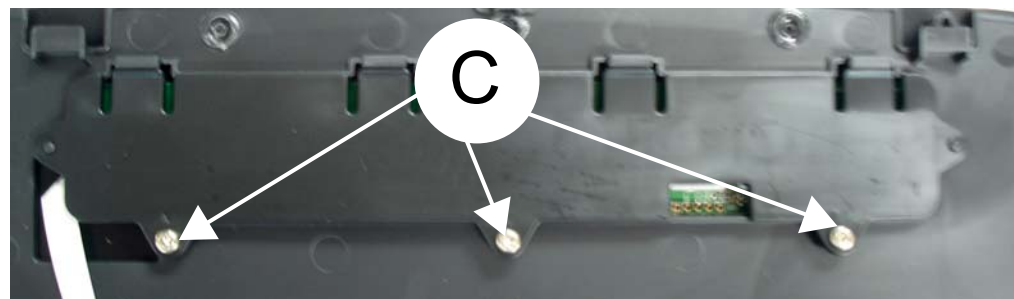

Figure 3

3 - 1
Dismantling of the VFD Board

- 1) Loosen 1 screws "D" on the top of VFD Board as shown in figure 4.

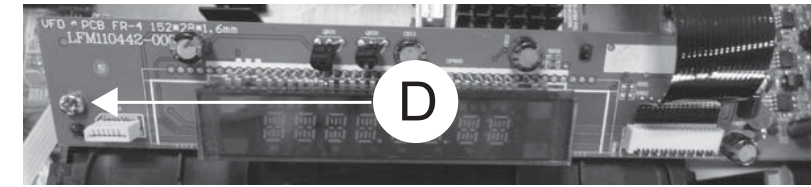

Figure 4

Dismantling of the DVD Module

- 1) Loosen 5 screws "E" at the DVD Module as shown in figure 5.

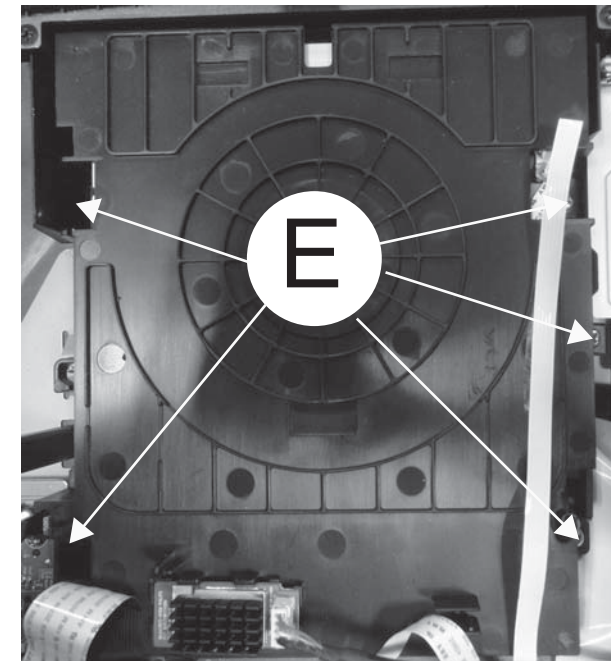

Figure 5

Dismantling of the MP3 & USB & SENSOR Board

- 1) Loosen 3 screws "F" on the top of MP3&USB Board as shown in figure 6.
- 2) Loosen 2 screws "G" on the top of SENSOR Board as shown in figure 7.

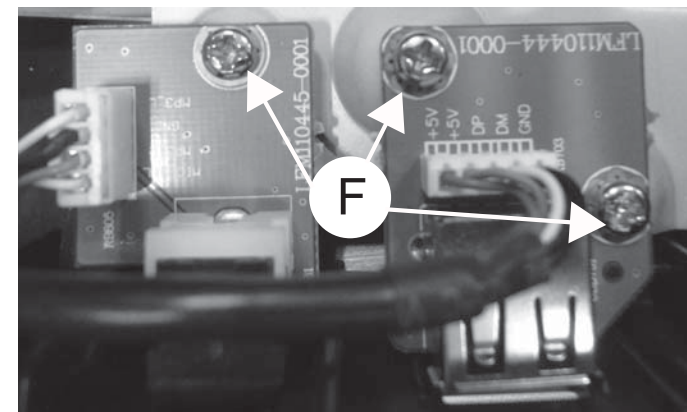

Figure 6

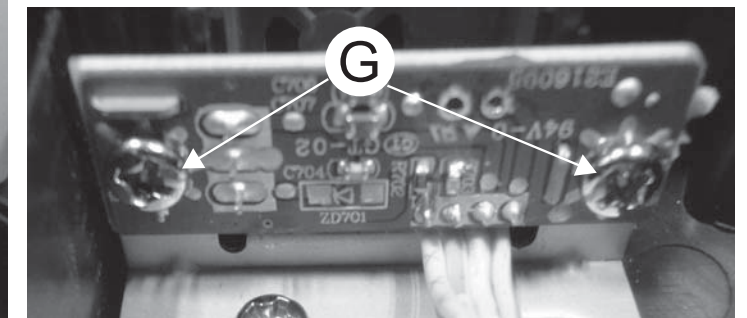

Figure 7

Dismantling of the BD Board

- 1) Loosen 4 screws "H" on the top of BD Board as shown in figure 8.
- 2) Loosen 1 screw "I" at the back panel as shown in figure 9.

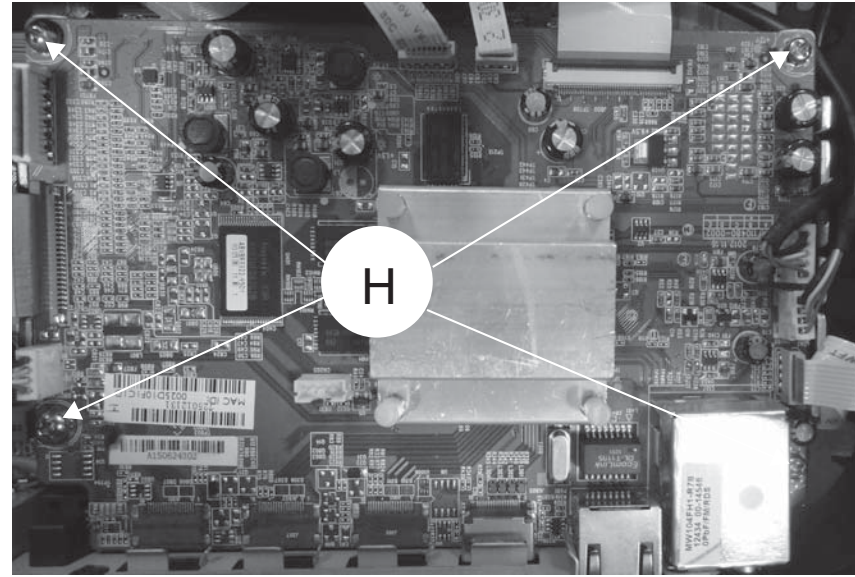

Figure 8



Figure 9

Dismantling of the MAIN Board

- 1) Loosen 6 screws "J" on the top of main board as shown in figure 10.
- 2) Loosen 2 screws "K" at the back panel as shown in figure 11

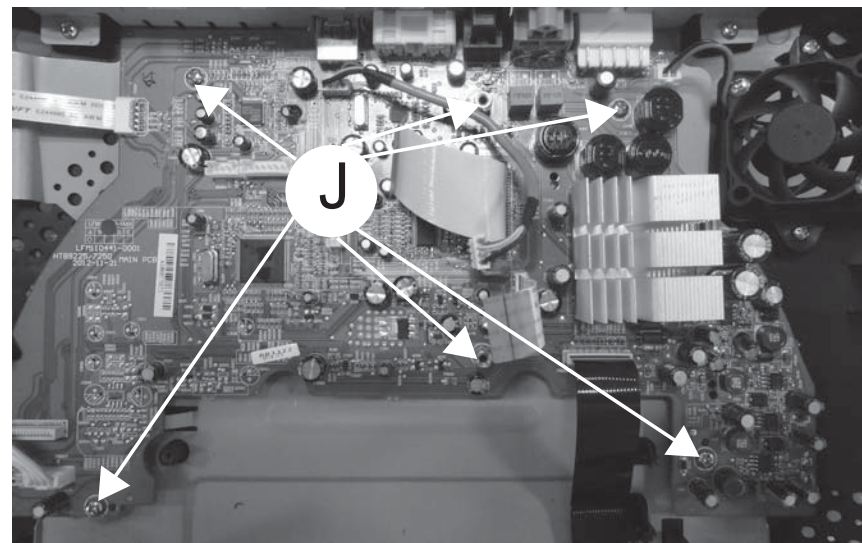

Figure 10



Figure 11

SERVICE POSITIONS (MAIN UNIT)

Service Position A - MAIN&BD Board

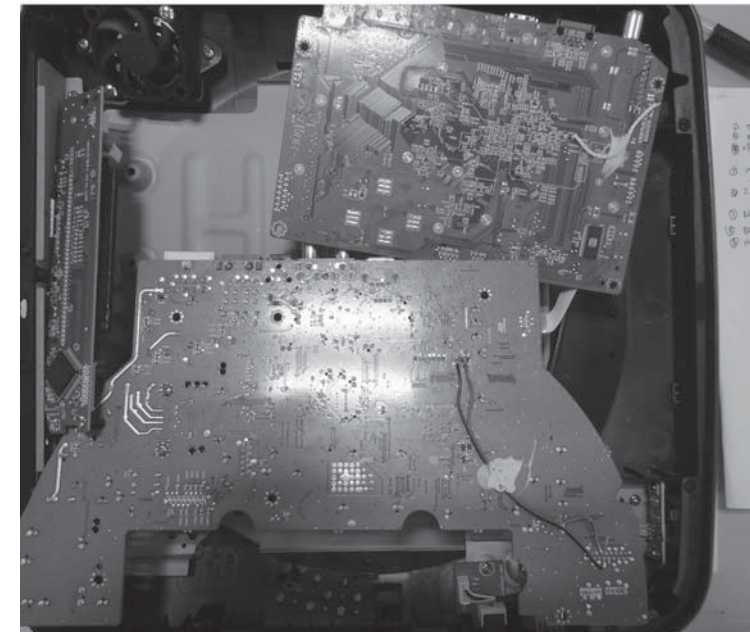

Service Position E - All Boards

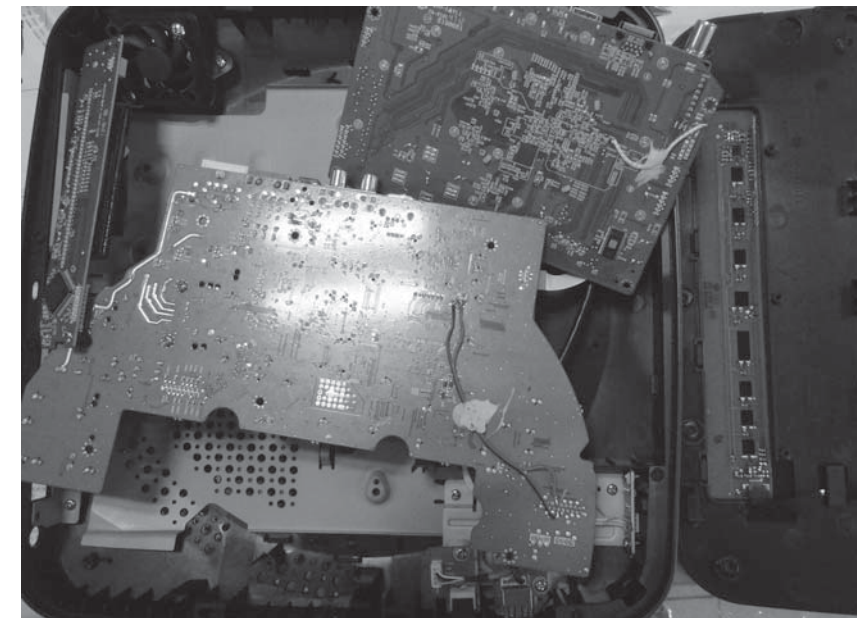

DISASSEMBLY INSTRUCTIONS-SUBWOOFER

Dismantling of the Subwoofer Rear Panel

1) Loosen 9 screws "Q" at the subwoofer rear panel as shown in figure 17.

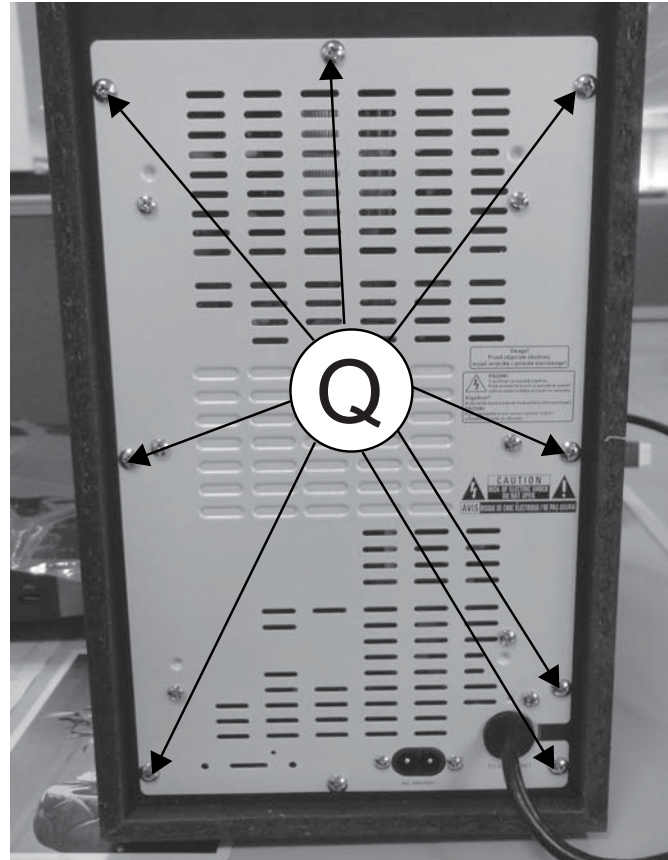

Figure 17

Dismantling of the Power Board

1) Loosen 5 screws "R" on the top of power board as shown in figure 18.

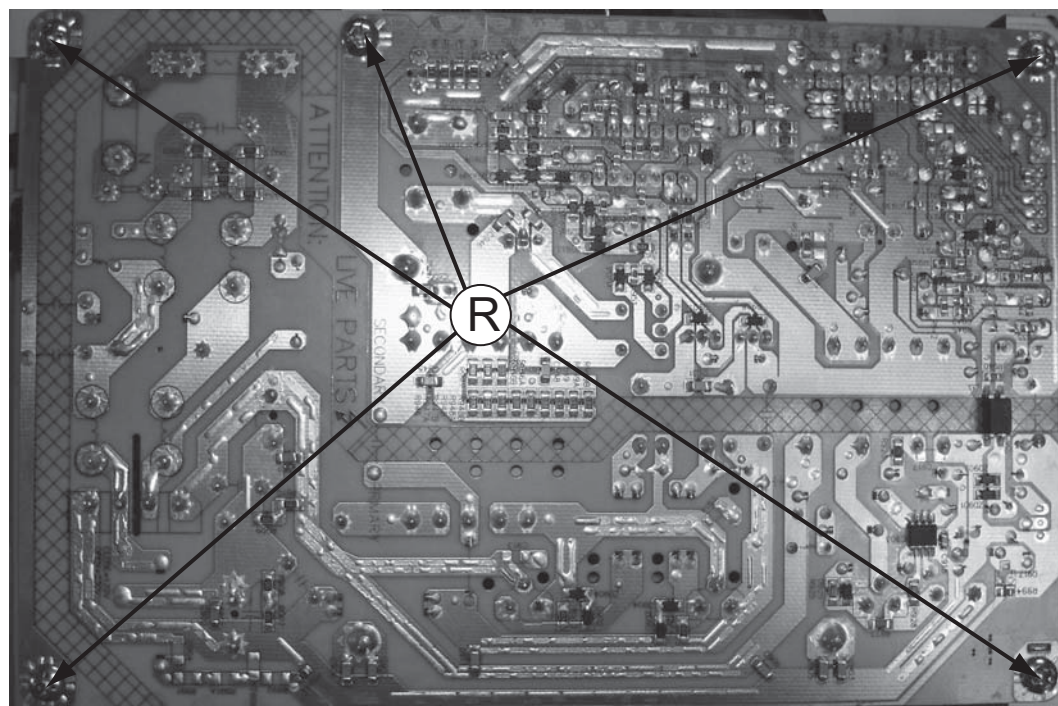

Figure 18

Dismantling of the Subwoofer AMP Board

1) Loosen 4 screws "S" on the top of subwoofer AMP board as shown in figure 19.

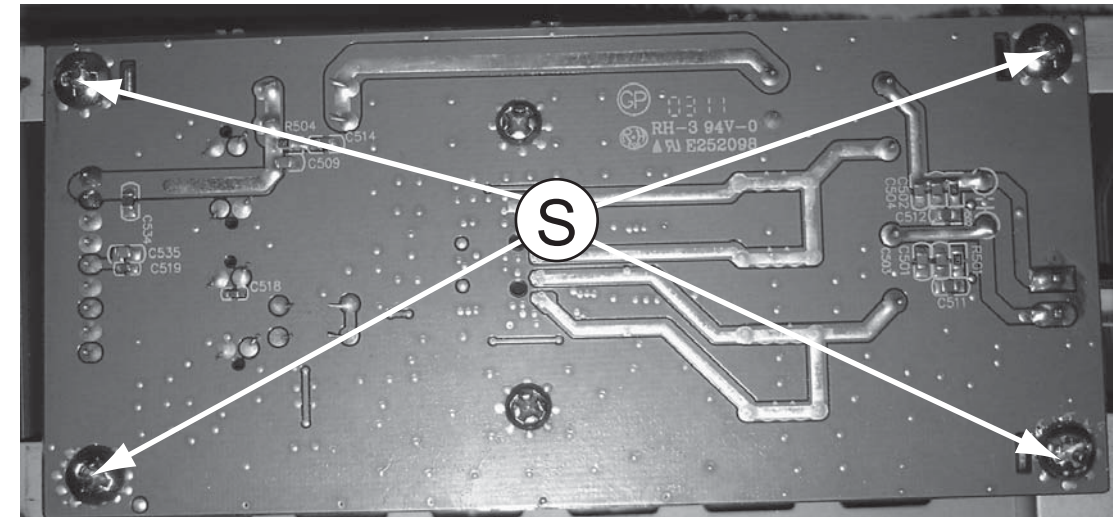
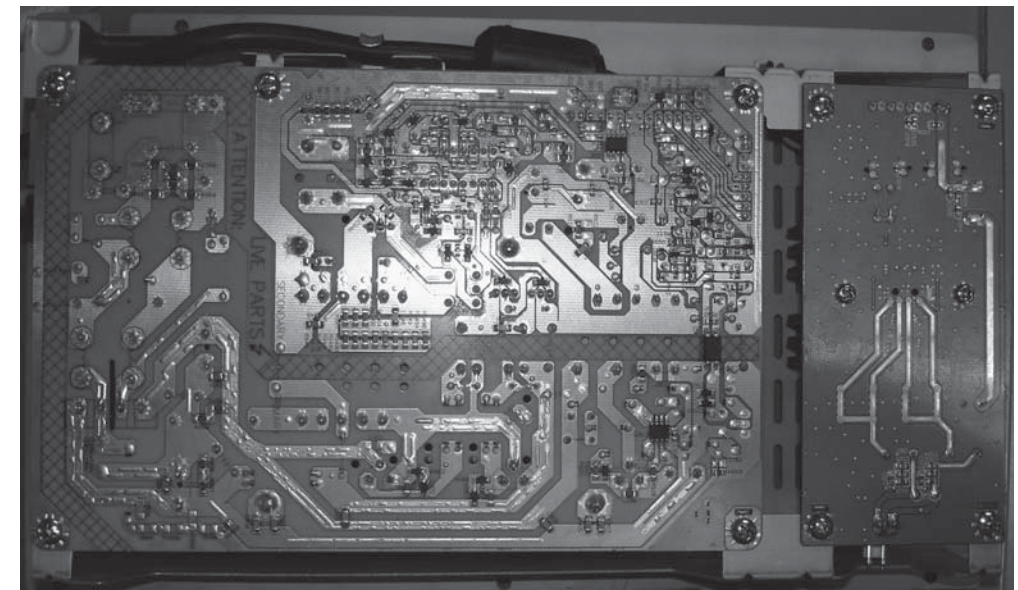
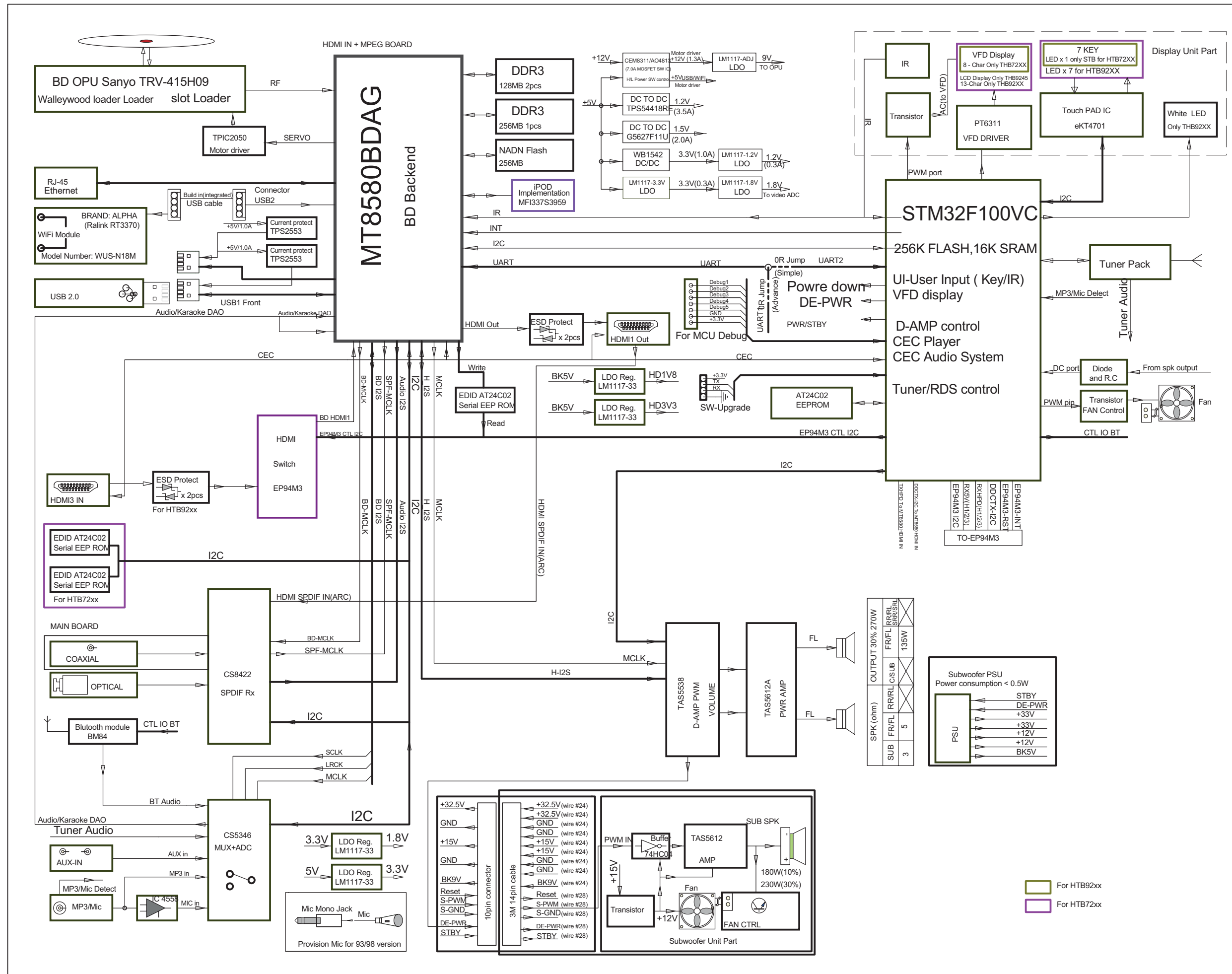

Figure 19

SERVICE POSITIONS (SUBWOOFER)





WIRING DIAGRAM

4 - 2

4 - 2

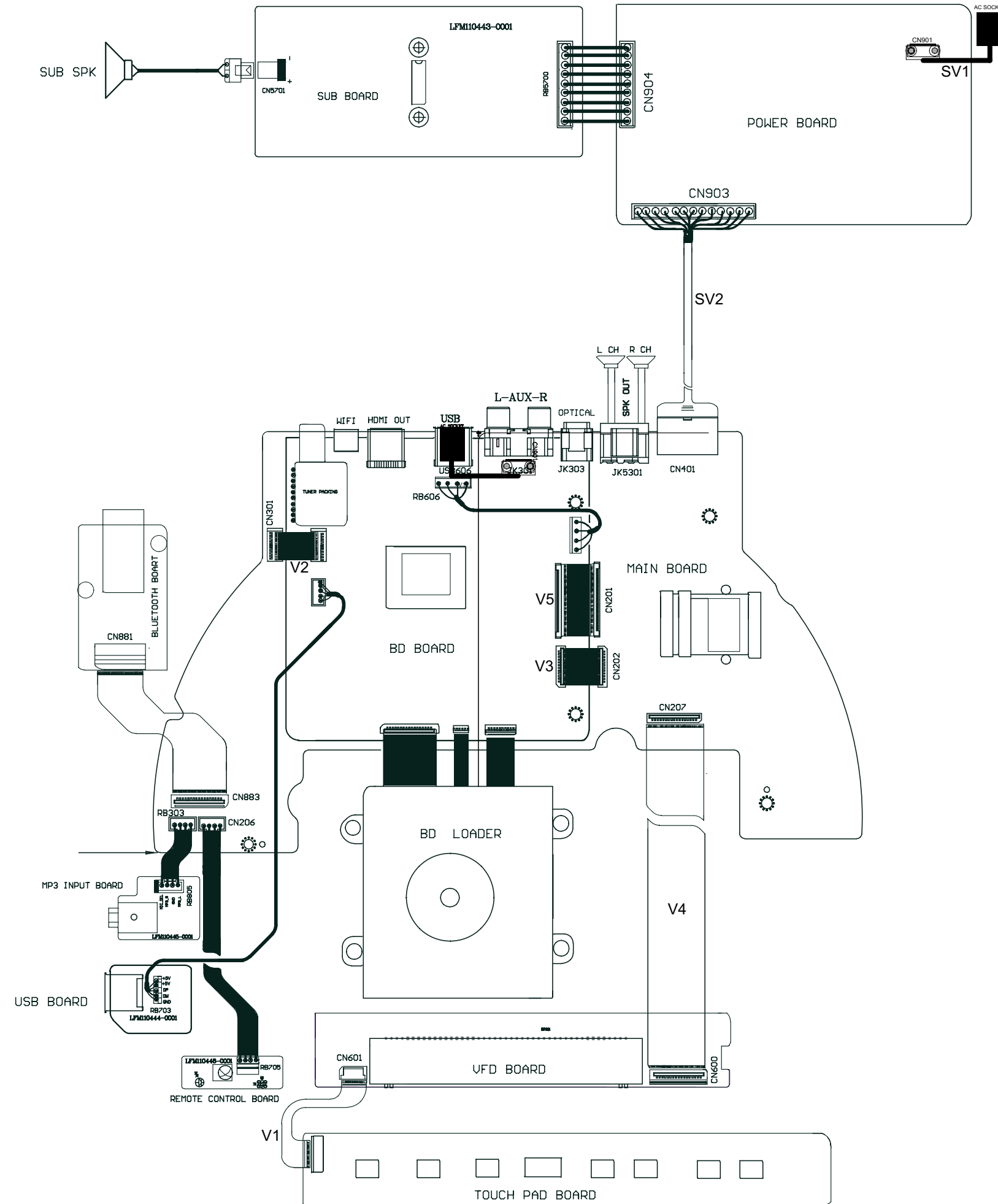

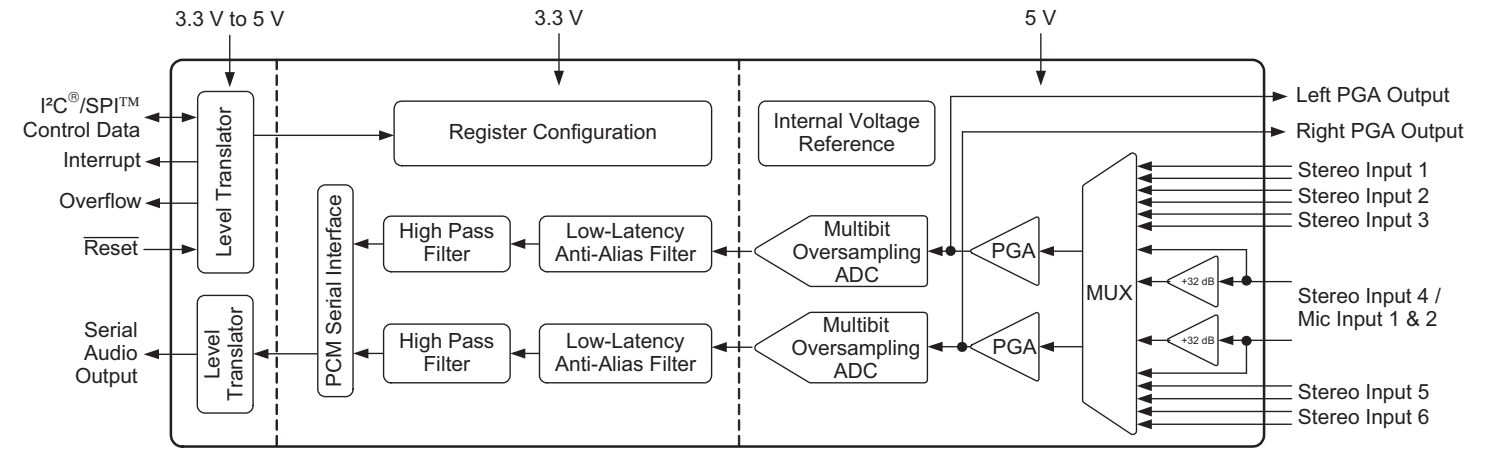

MAIN+VFD+SUB+USB+MP3+SENSOR+BT BOARD

TABLE OF CONTENTS

Internal IC Diagram 5-1
 Circuit Diagram 5-3
 PCB Layout Top View 5-4
 PCB Layout Bottom View 5-5

IC201 INTERNAL IC DIAGRAM - STM32F100VBT6BATR

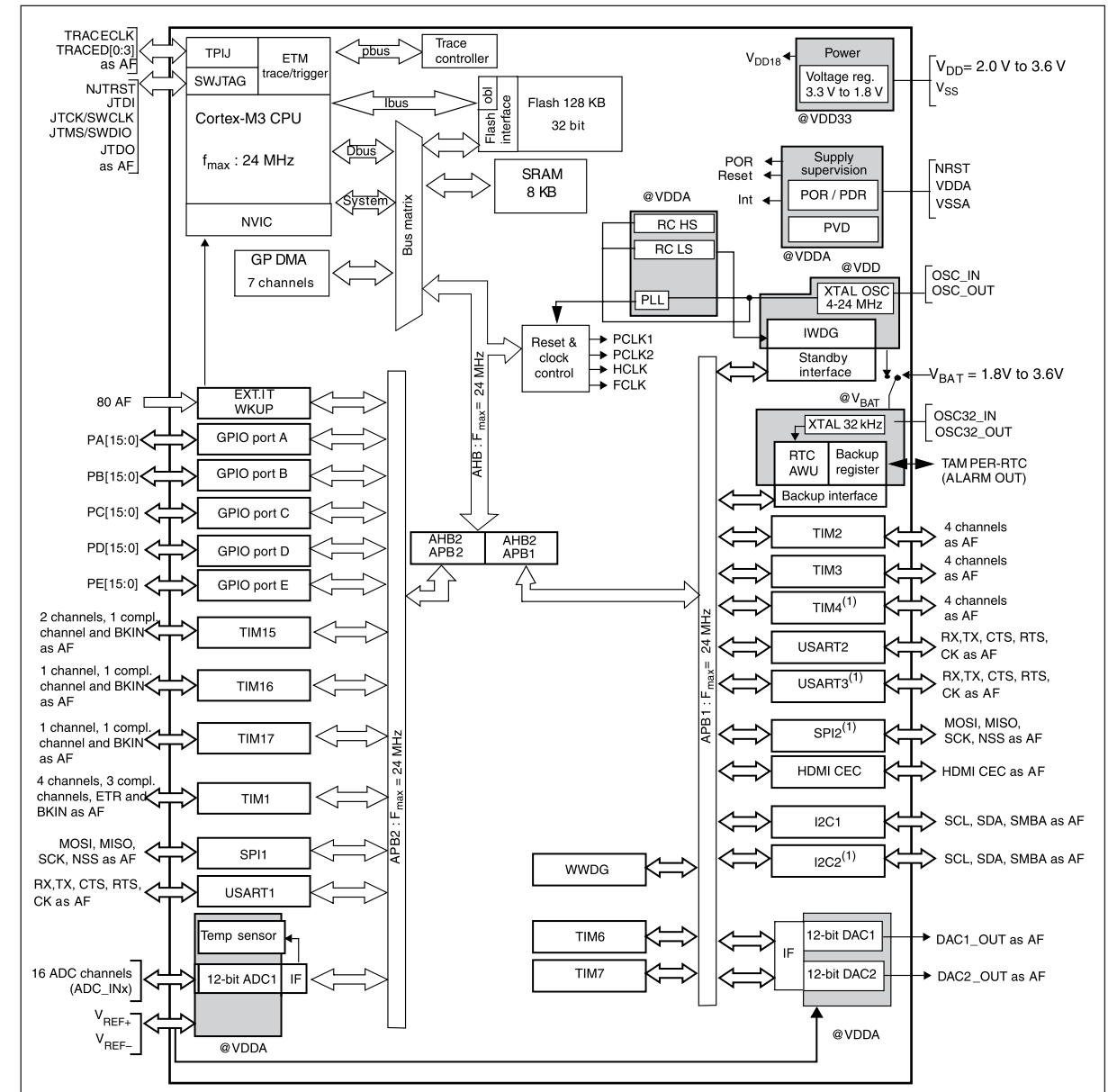

IC4103 INTERNAL IC DIAGRAM - TAS5538 DGG

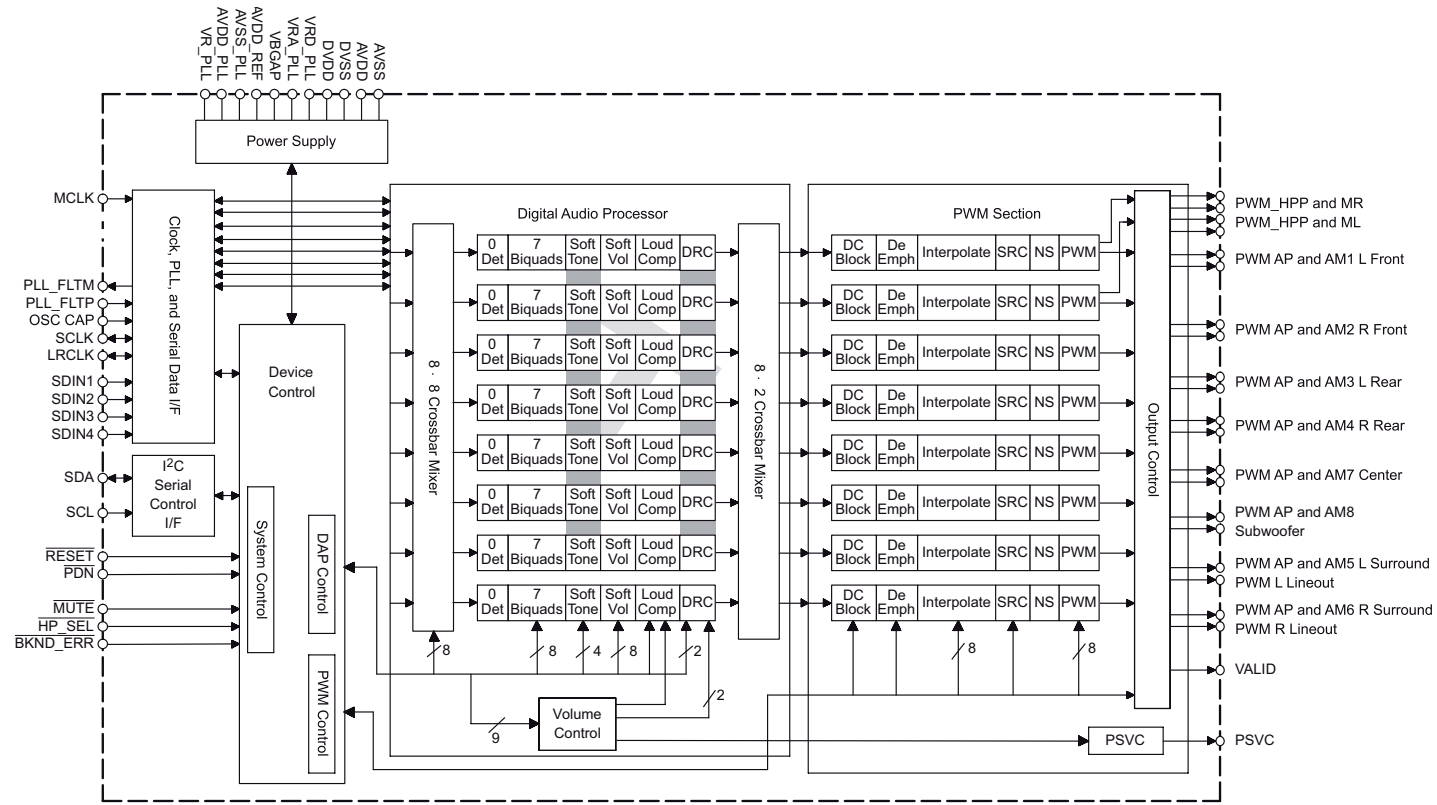

IC305 INTERNAL IC DIAGRAM - CS8422-CNZR QFN

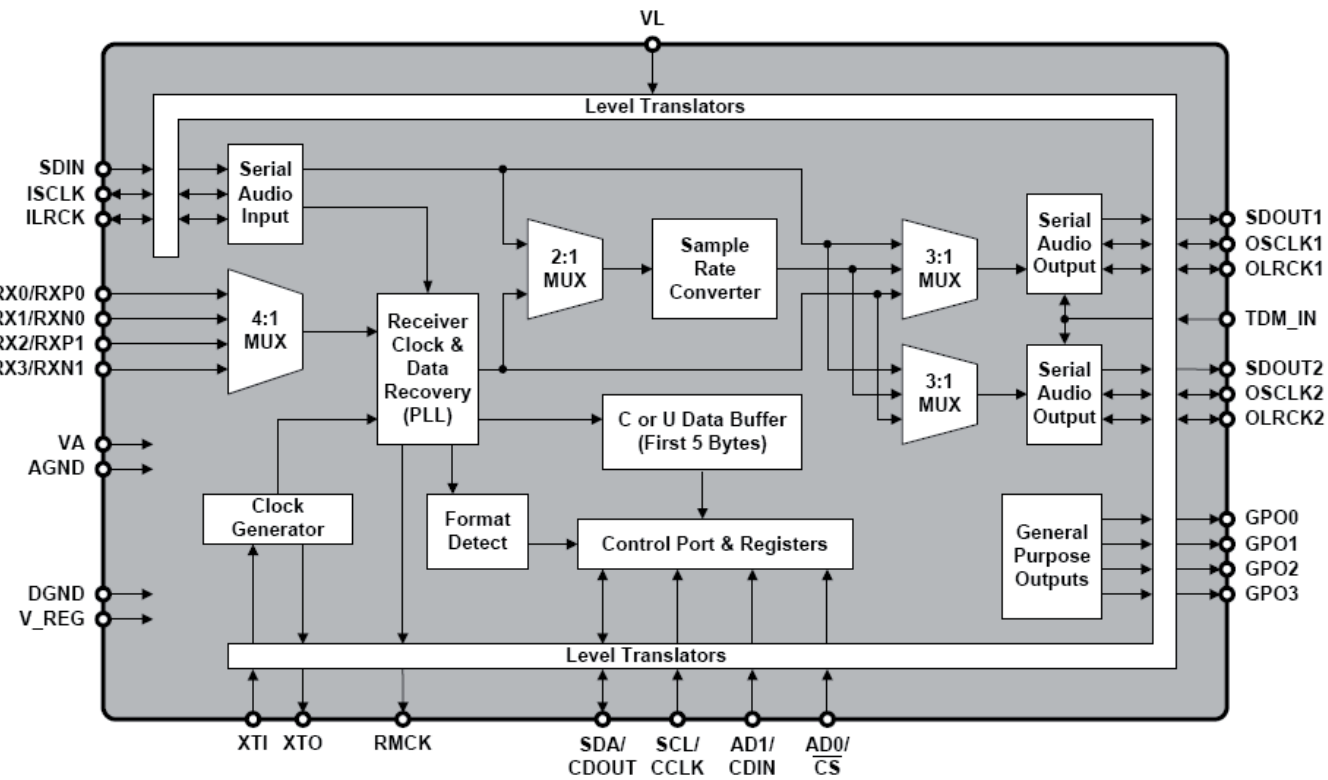

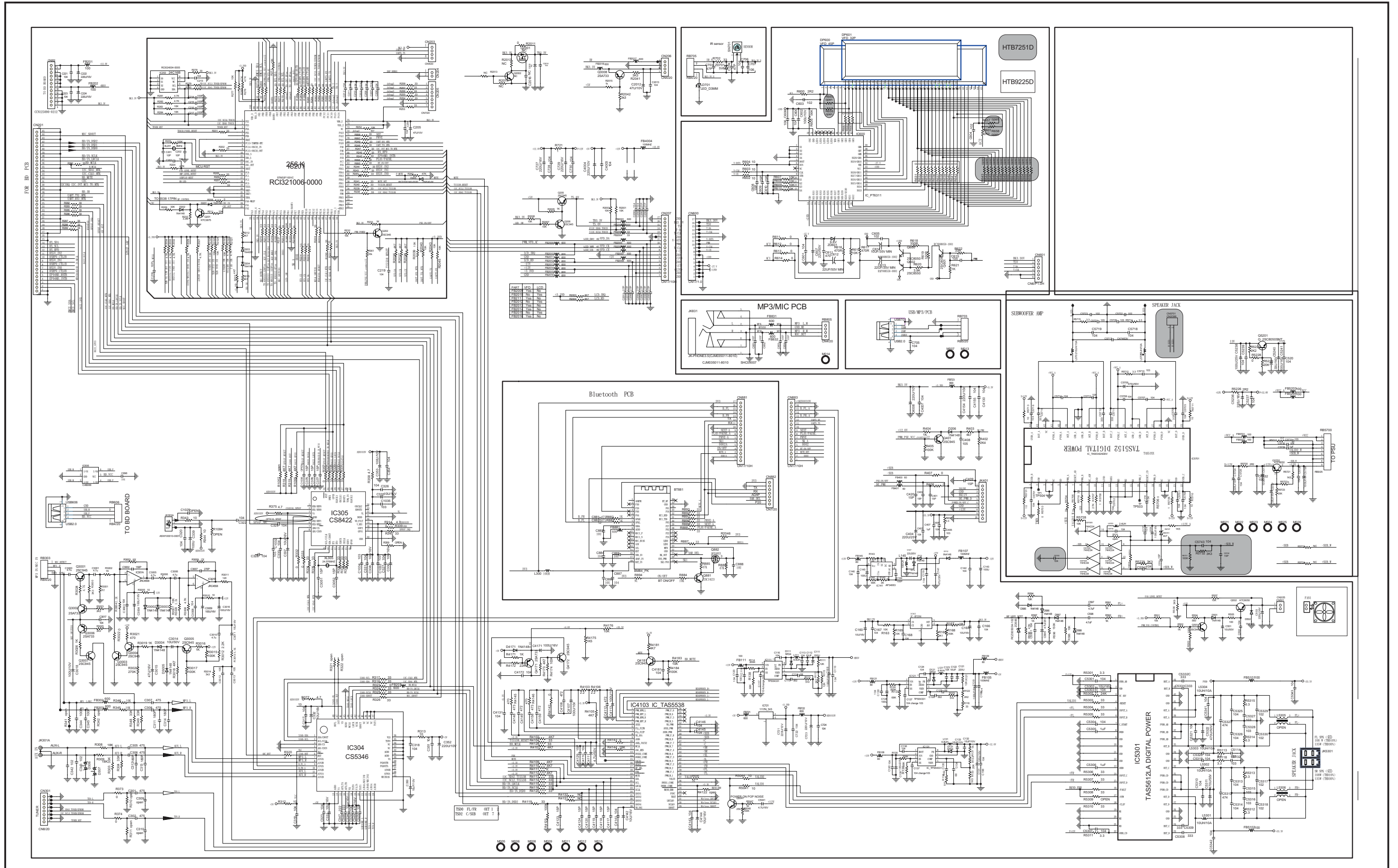

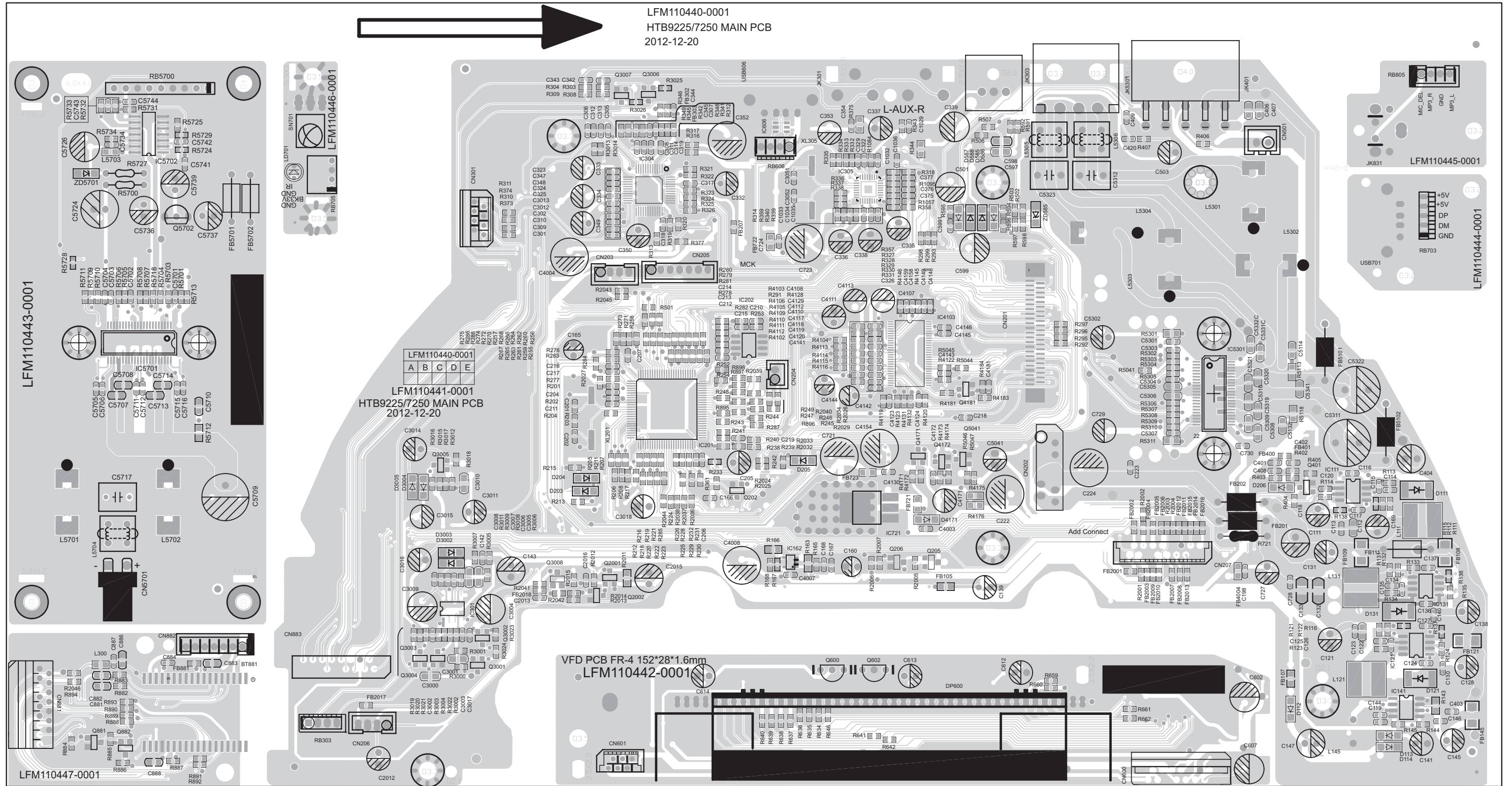

PCB LAYOUT - BOTTOM VIEW

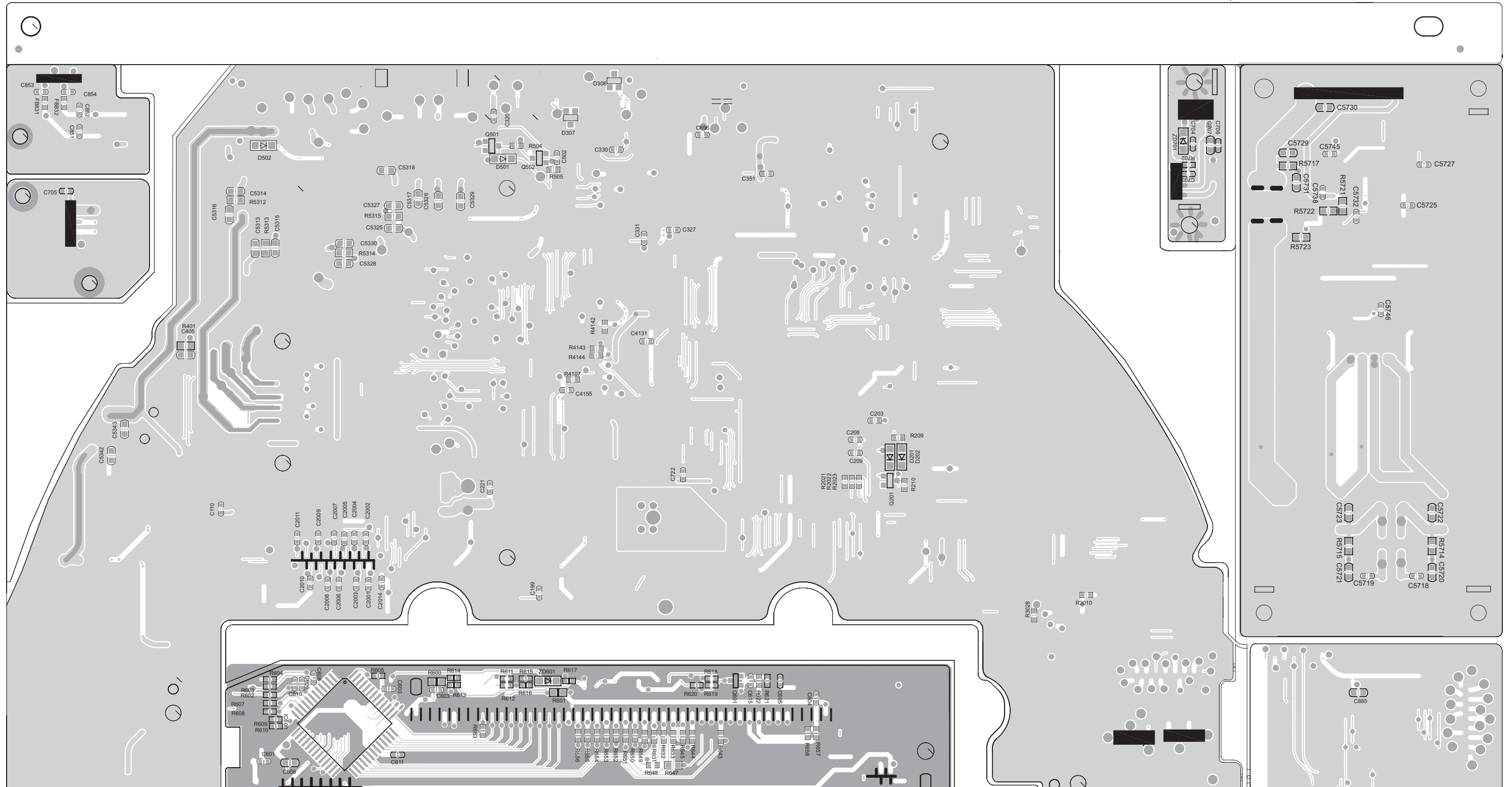

BD BOARD

TABLE OF CONTENTS

Block Diagram(BD Board) 6-1
 Voltages for connector pin 6-2
 Waveforms for measure point 6-3

BLOCK DIAGRAM

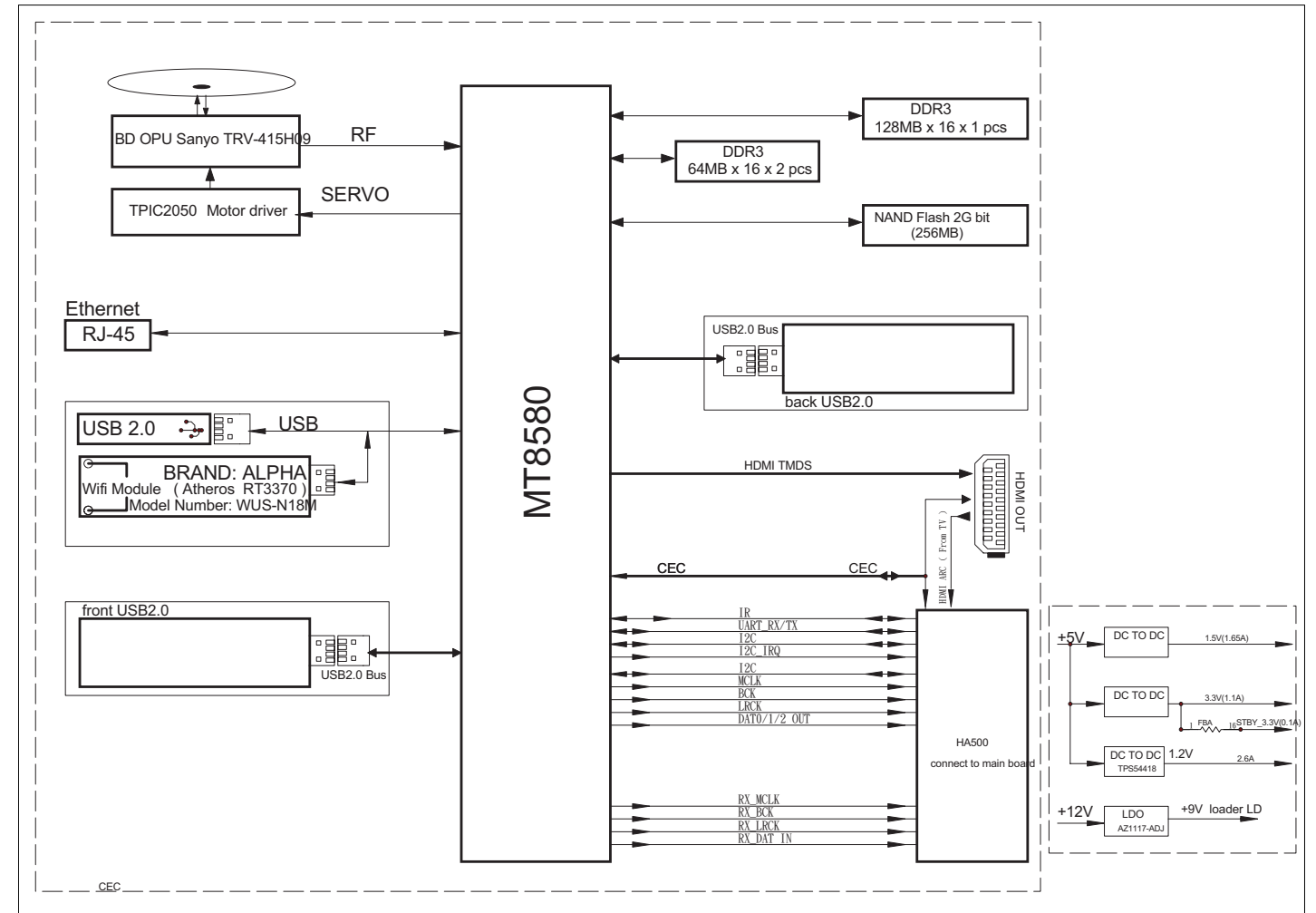

Voltages for connector pin

1. HA501--->>from BD board connect to main board

PIN NO	PIN Assign	Remarks
1	GND	
2	MIC_IN	
3	GND	
4	DATA2	
5	DATA1	
6	DATA0	
7	GND	
8	BCK	
9	LRCK	
10	MCLK	
11	GND	
12	SDA	
13	SCL	
14	AMUTE	high and low cotrol
15	CEC	
16	I2C_IRQ	high and low cotrol
17	GND	
18	IR	
19	IPOD_RXD	
20	IPOD_TXD	
21	ADC_RST	working High reset low
22	SPDIF_RST	working High reset low
23	SPDIF_IRQ	high and low cotrol
24	RX_DATA0	
25	GND	
26	RX_BCK	
27	RX_LRCK	
28	RX_MCLK	
29	GND	
30	SPDIF_ARC	
31	GND	
32	HDMI_RX_SDA	NC
33	HDMI_RX_SCL	NC
34	HDMI_RX_HPD	NC
35	RX5V_IN2	NC
36	RXHPD_CTL2b	NC
37	RX5V_IN1	NC
38	RXHPD_CTL1b	NC
39	RX5V_IN0	NC
40	RXHPD_CTL0b	NC
41	EP94M3_RSTb	NC
42	EP94M3_INTb	NC
43	HMCU_SCL	
44	HMCU_SDA	
45	GND	

2. J800--->>from BD board connect to BD loader(SERVO use)

PIN NO	PIN Assign	Remarks
1	FOC2+	
2	FOC2-	
3	TR-	
4	FOC1+	
5	TR+	
6	FOC1-	
7	CO_A-	
8	CO_B-	
9	CO_A+	
10	CO_B+	
11	GND	
12	SIG_PO	
13	GND	
14	INB	
15	INA	
16	IND	
17	INC	
18	ING	
19	INH	
20	INF	
21	INE	
22	LDO_SDIO	
23	RFO+	
24	RFO-	
25	LDD_CLK	
26	FEGAINSW3	
27	HAVCC	
28	VCC_PDIC	
29	GND	
30	GAINSW1	
31	GND	
32	BD_LD	
33	CD_LD	
34	DVD_LD	
35	GND	
36	AUX1	
37	VCC_HFM	
38	MDI_DVD	
39	MDI_BD	
40	DVD_VR	
41	CD_VR	
42	GND	
43	HFA_CD	
44	GND	
45	GND	

3. CN201--->>from BD board connect to main board(Rear USB)

PIN NO	PIN Assign	Remarks
1	USB+5V	4.75V-5.25V
2	USBM	High speed difference
3	USBP	
4	GND	

4. CN203--->>from BD board connect to WIFI connect PCB

PIN NO	PIN Assign	Remarks
1	USB+5V	4.75V-5.25V
2	USBM	High speed difference
3	USBP	
4	GND	

5. CN202--->>from BD board connect to USB connect PCB(front USB)

PIN NO	PIN Assign	Remarks
1	USB+5V	4.75V-5.25V
2	USB+5V	
3	USBM	High speed difference
4	USBP	
5	GND	

6. J901 --->>from BD board connect to BD loader(SERVO use)

PIN NO	PIN Assign	Remarks
1	_LOAD-	
2	_LOAD+	
3	GND	
4	TYAY_IN	
5	TYAY_OUT	

7. J900 --->>from BD board connect to BD loader(SERVO use)

PIN NO	PIN Assign	Remarks
1	U	
2	V	
3	W	
4	COMMON	
5	B+	
6	B-	
7	A-	
8	A+	

8. CN4 --->>from BD board connect to MAIN board

PIN NO	PIN Assign	Remarks
		HDMI_RX Switch VCC: 2.97V-3.63V
1	BK3.3V	
2	GND	
3	GND	
4	GND	
5	GND	
6	+5V	BD main VCC+5V: 4.75V-5.25V
7	+5V	
8	+5V	
9	+5V	
10	+5V	
11	+5V	
	+12V	motor driver VCC+12V :10.8-13.2V
12		

Waveforms for measure point

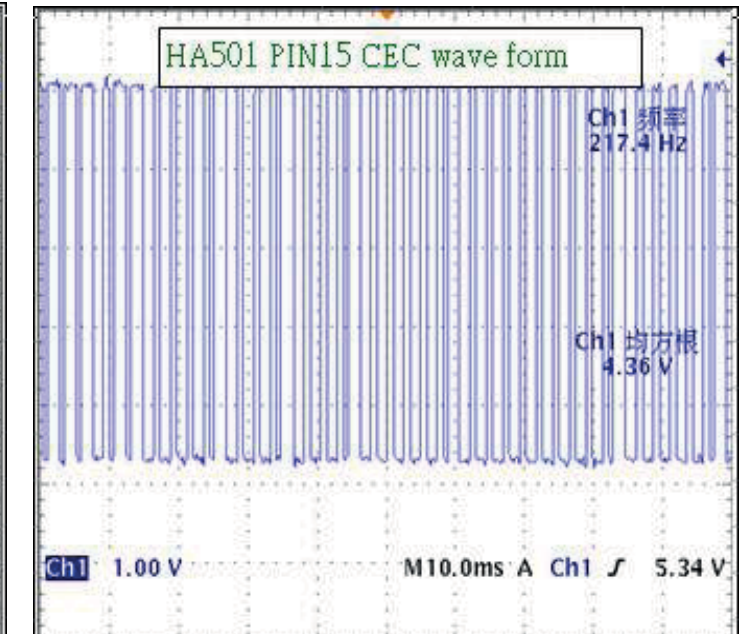
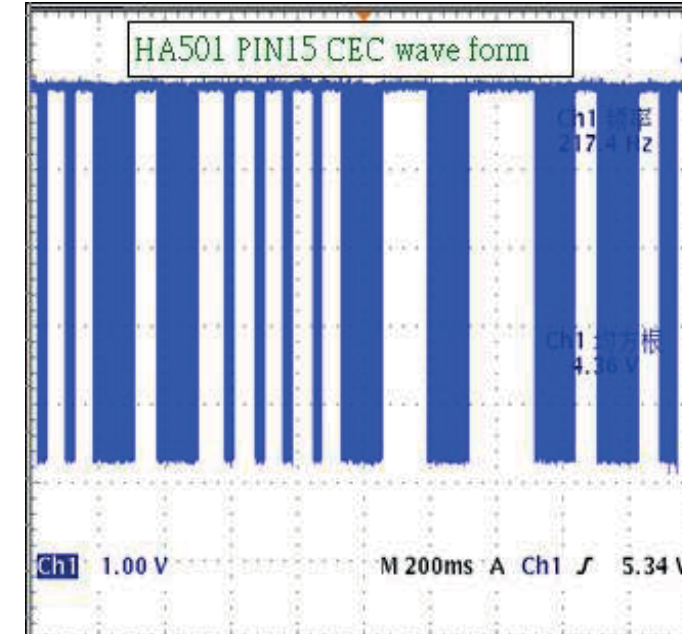
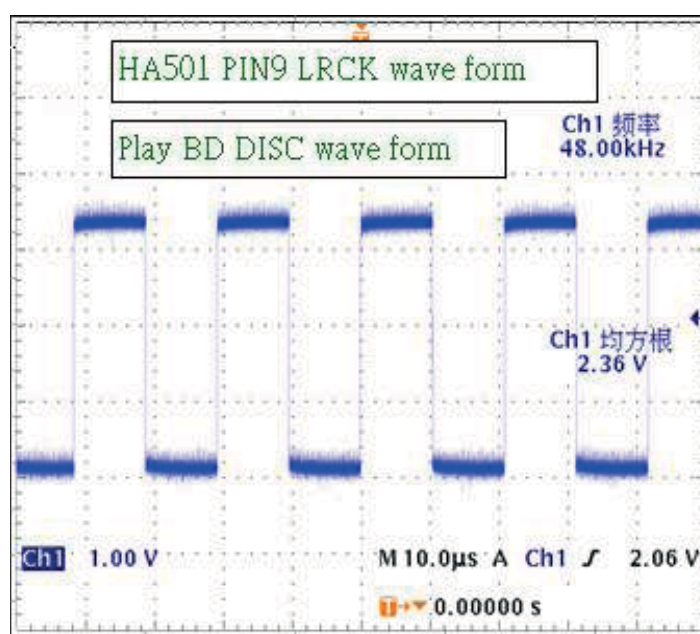
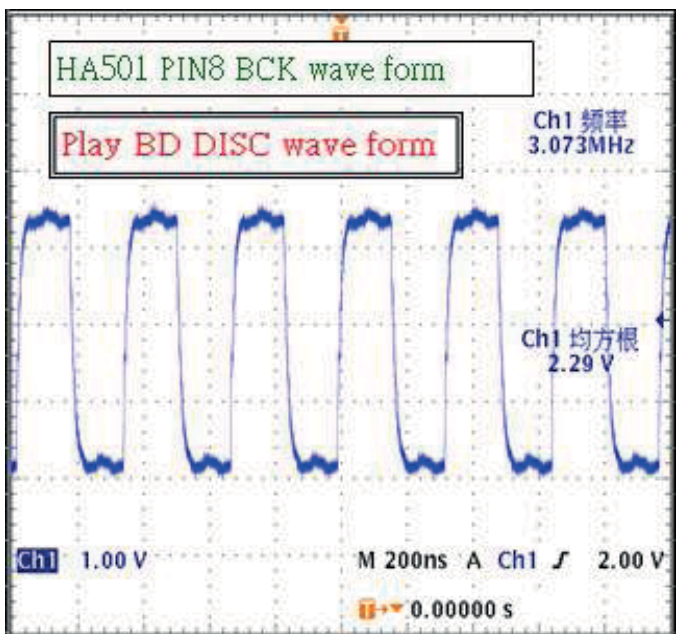
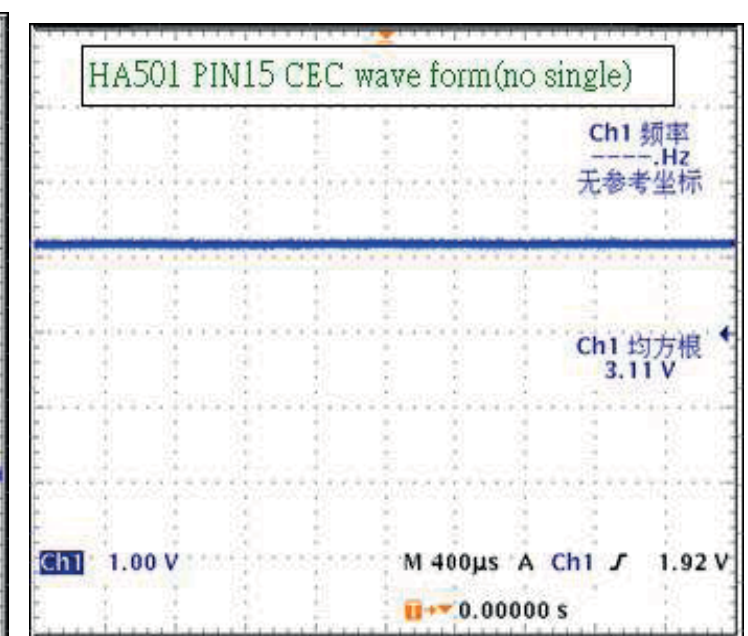
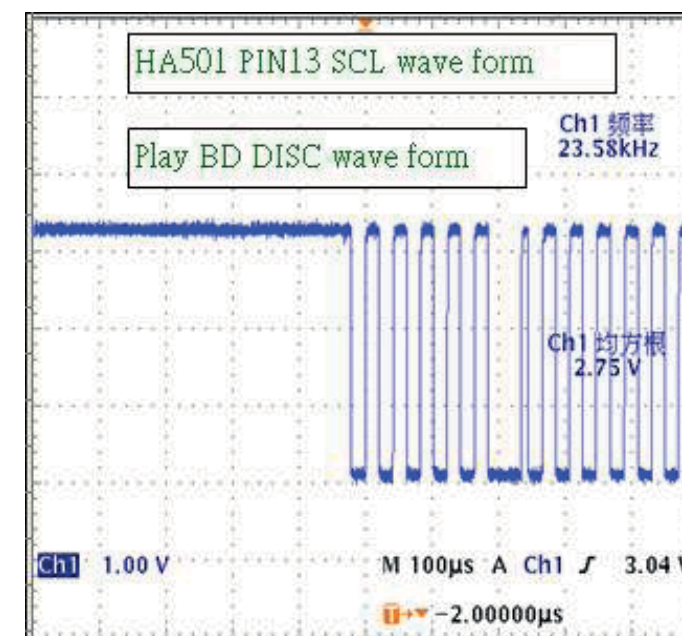
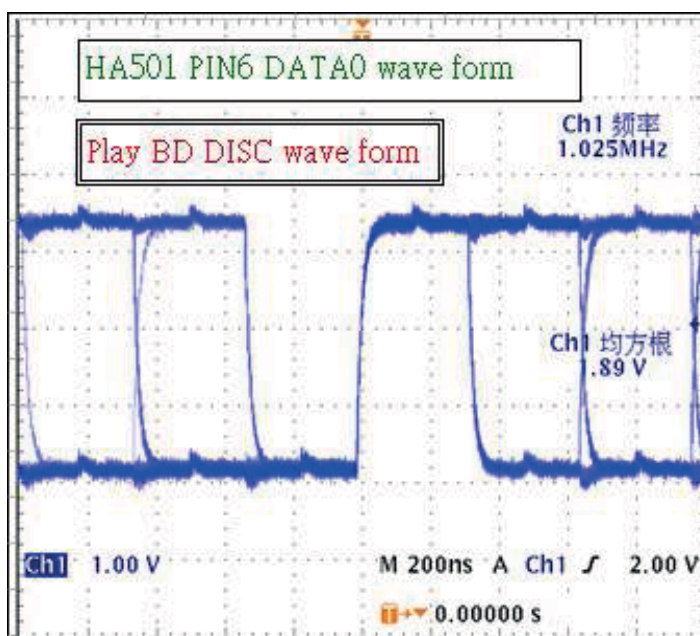
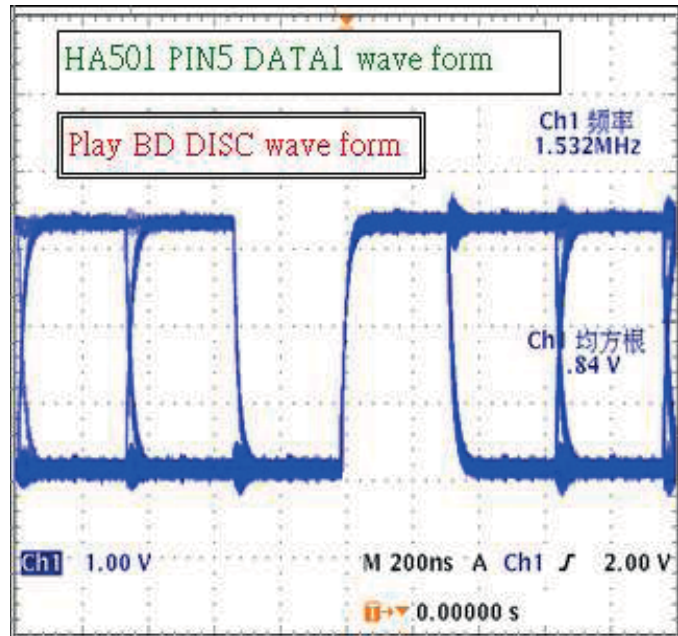
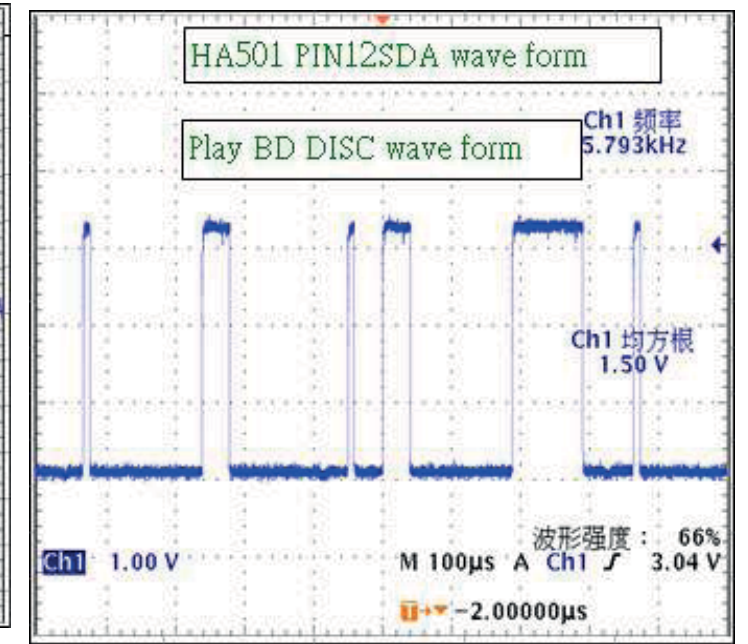
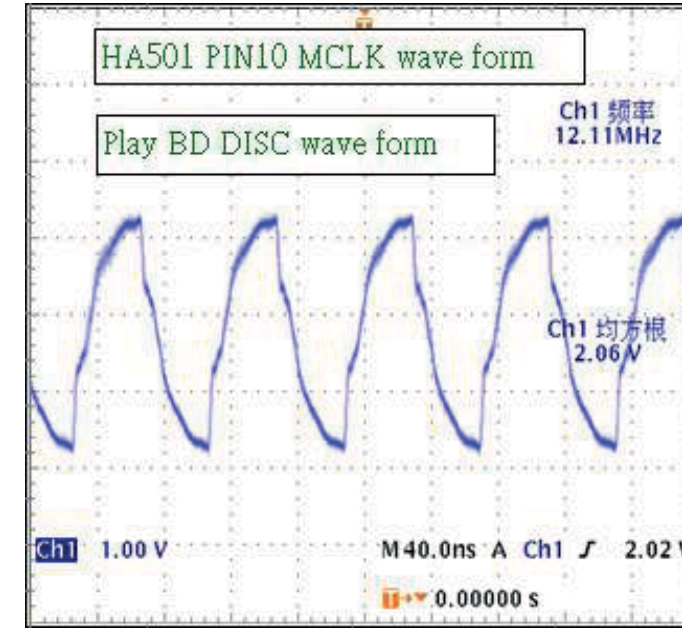
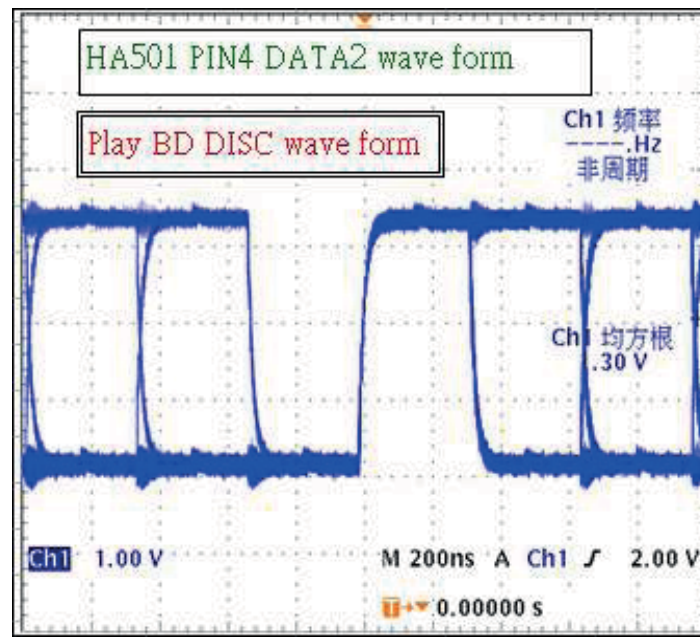
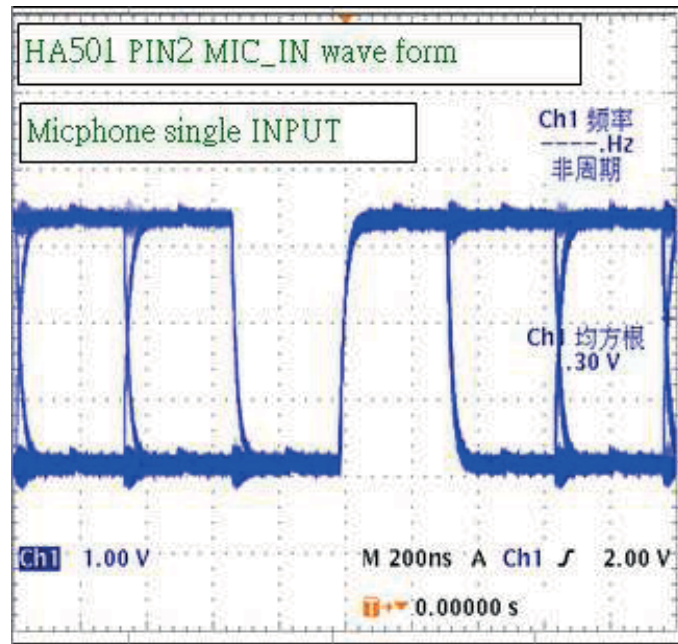

Waveforms for measure point

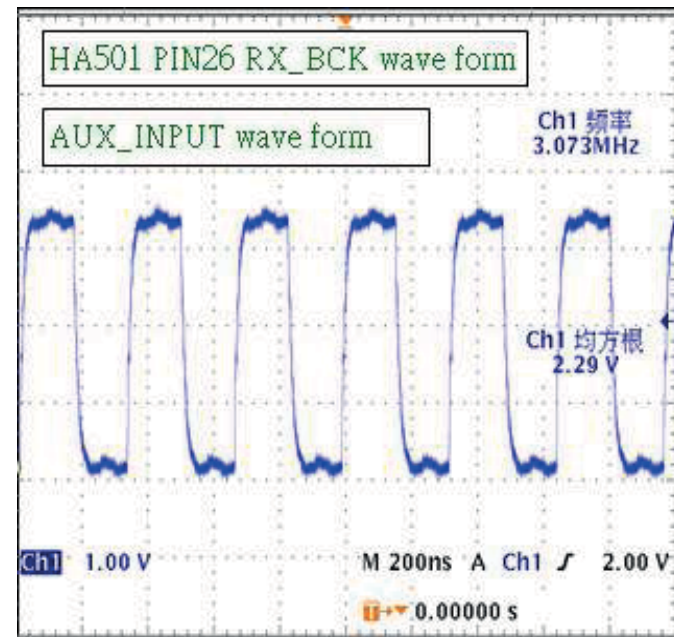
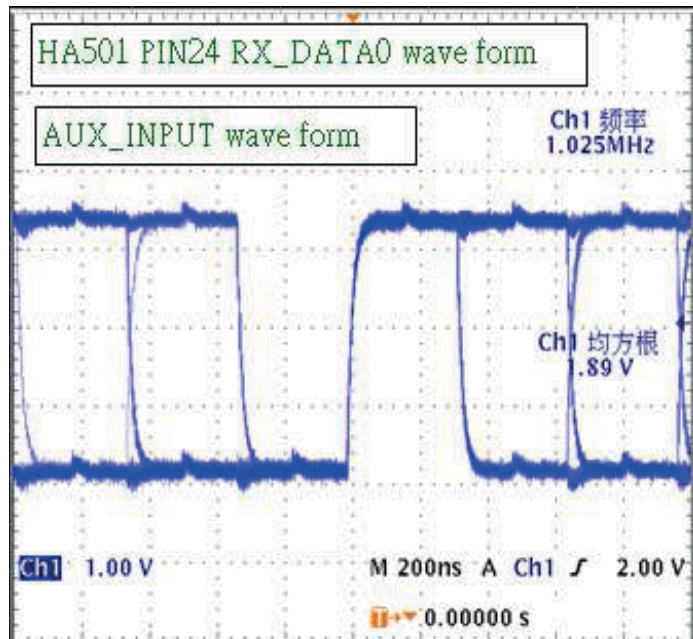
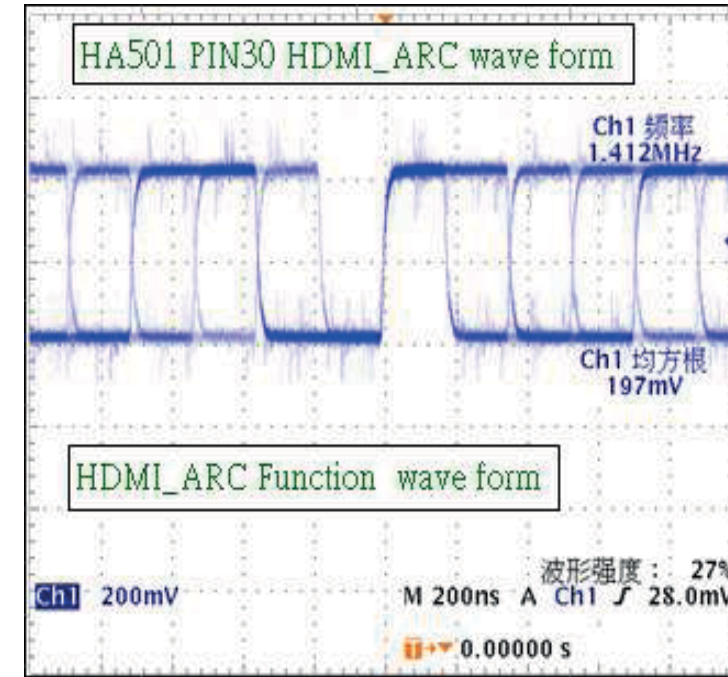
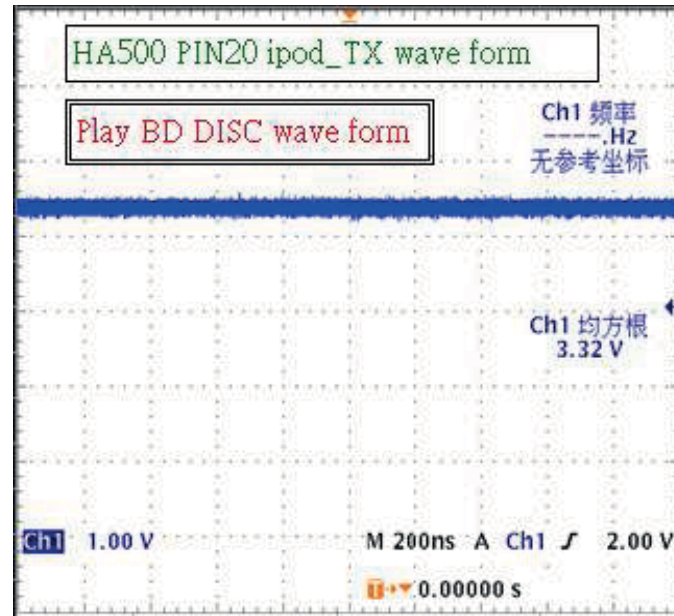
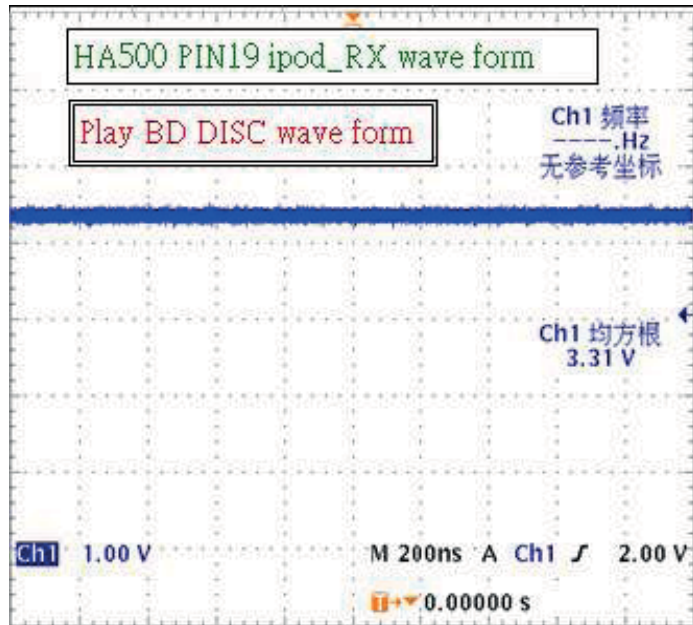
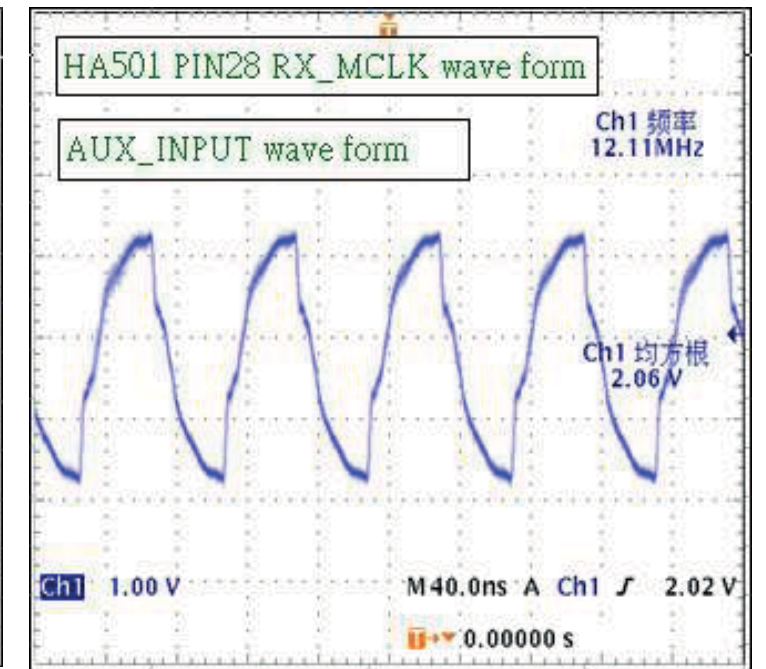
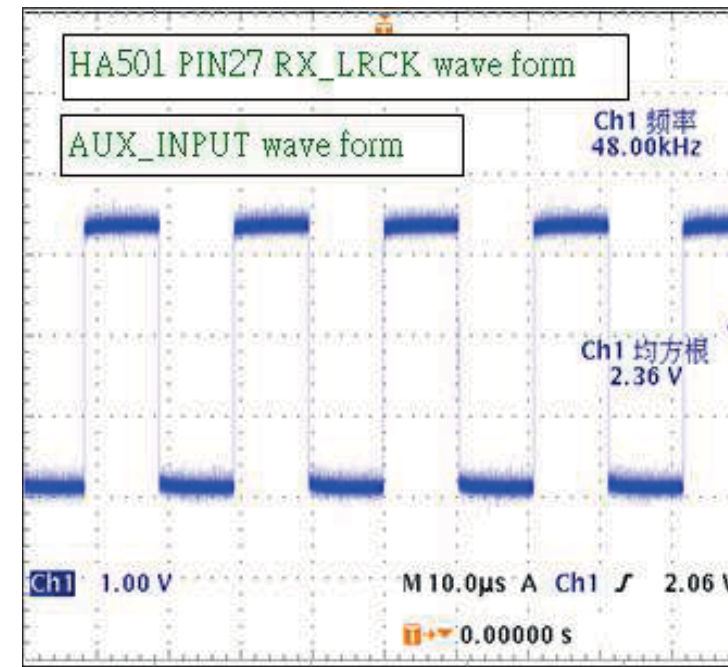
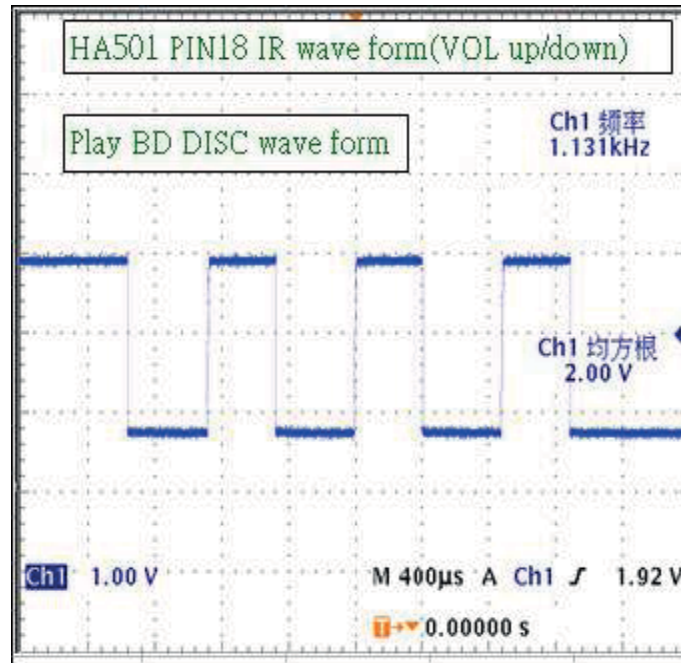
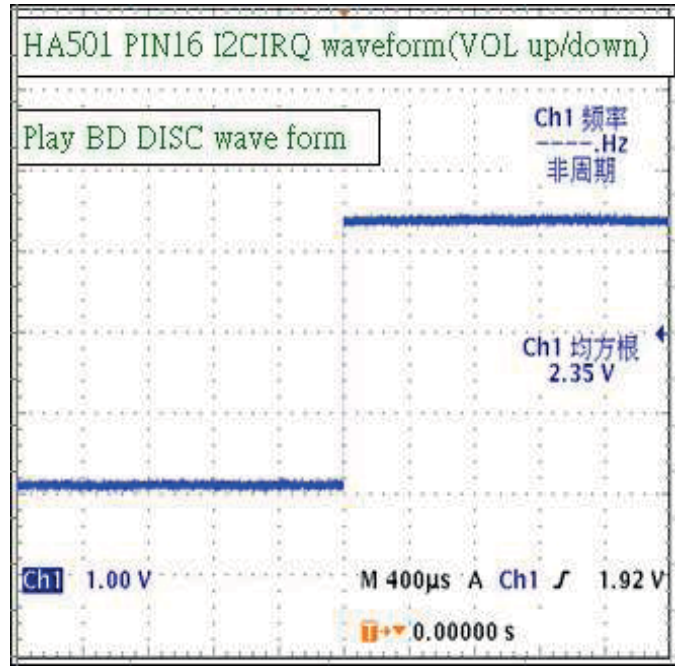

TOUCH BOARD

TABLE OF CONTENTS

Circuit Diagram 7-2
PCB Layout Top & Bottom View 7-3

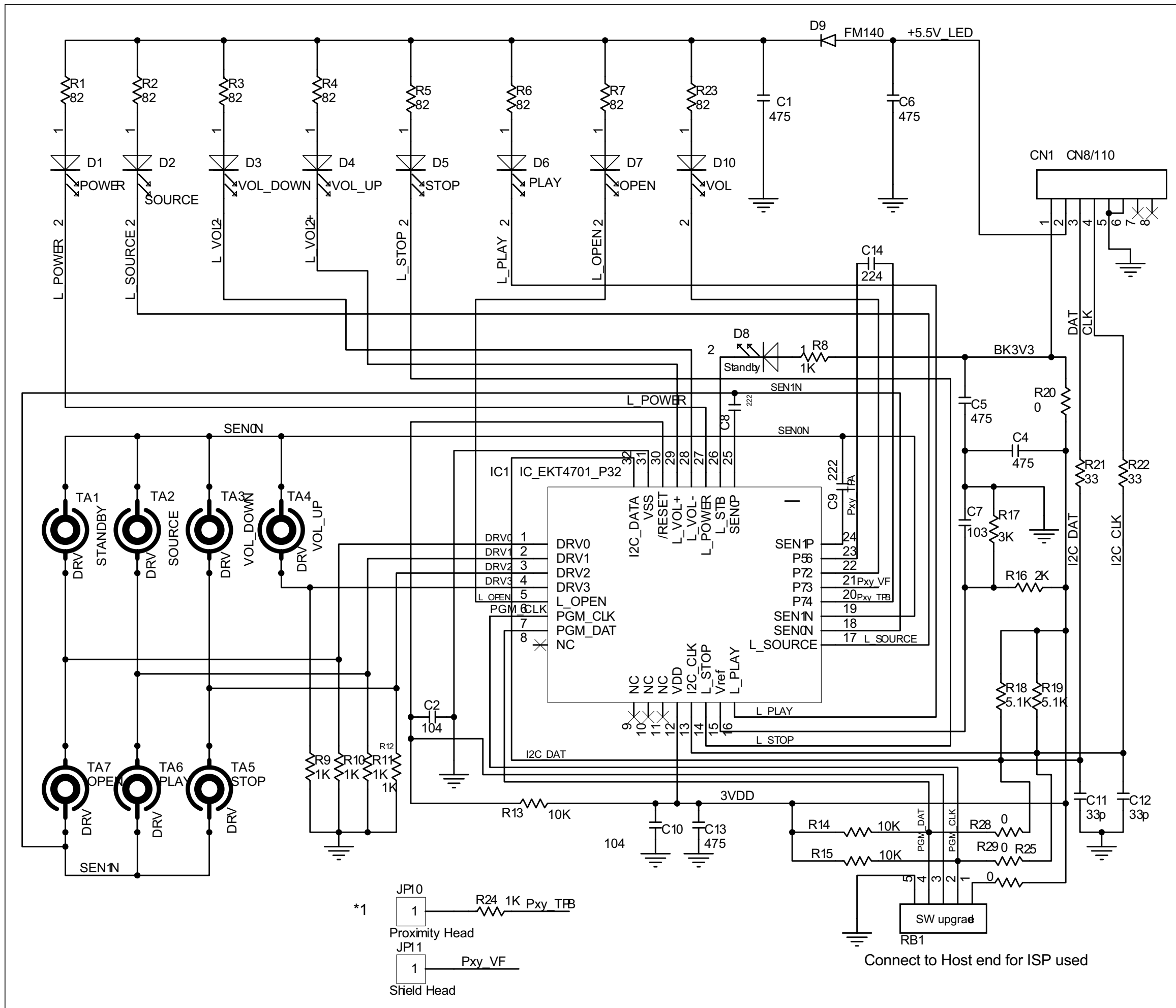

PCB LAYOUT - TOP VIEW

7-3

7-3

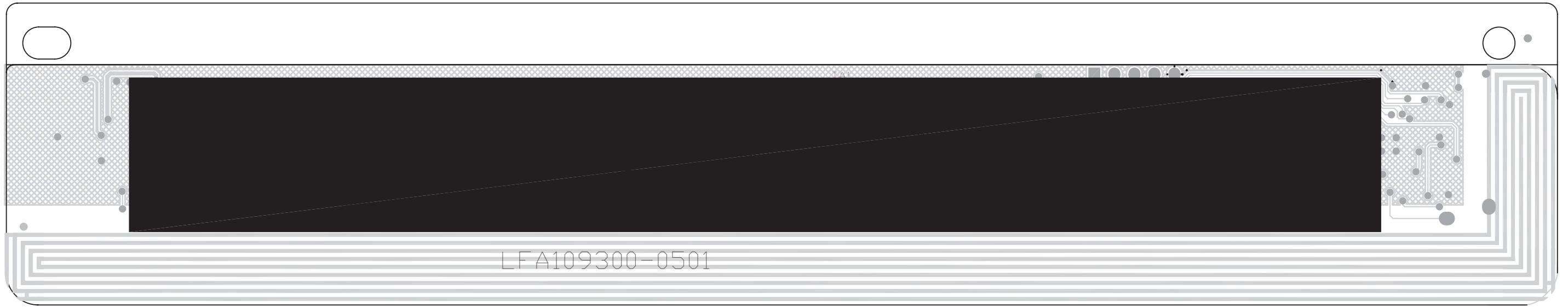

PCB LAYOUT - BOTTOM VIEW

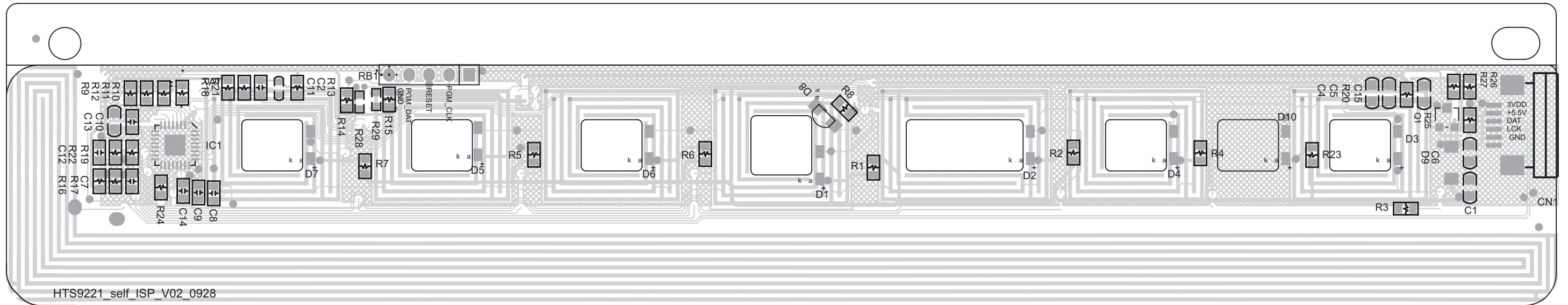

POWER BOARD

TABLE OF CONTENTS

Internal IC Diagram 8-1
 Circuit Diagram 8-2
 PCB Layout Top View 8-3
 PCB Layout Bottom View 8-4

8 - 1
IC905 INTERNAL IC DIAGRAM - AZ7500BP

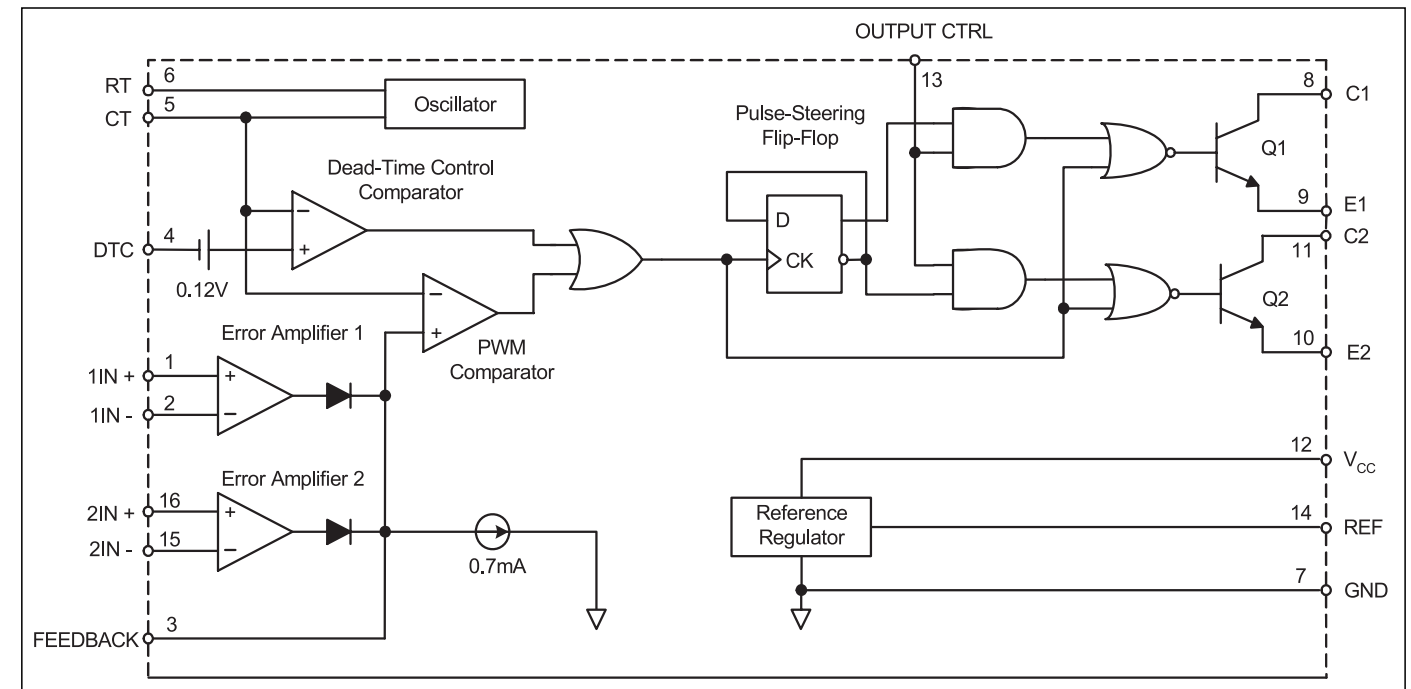

IC903 INTERNAL IC DIAGRAM - SSC620S

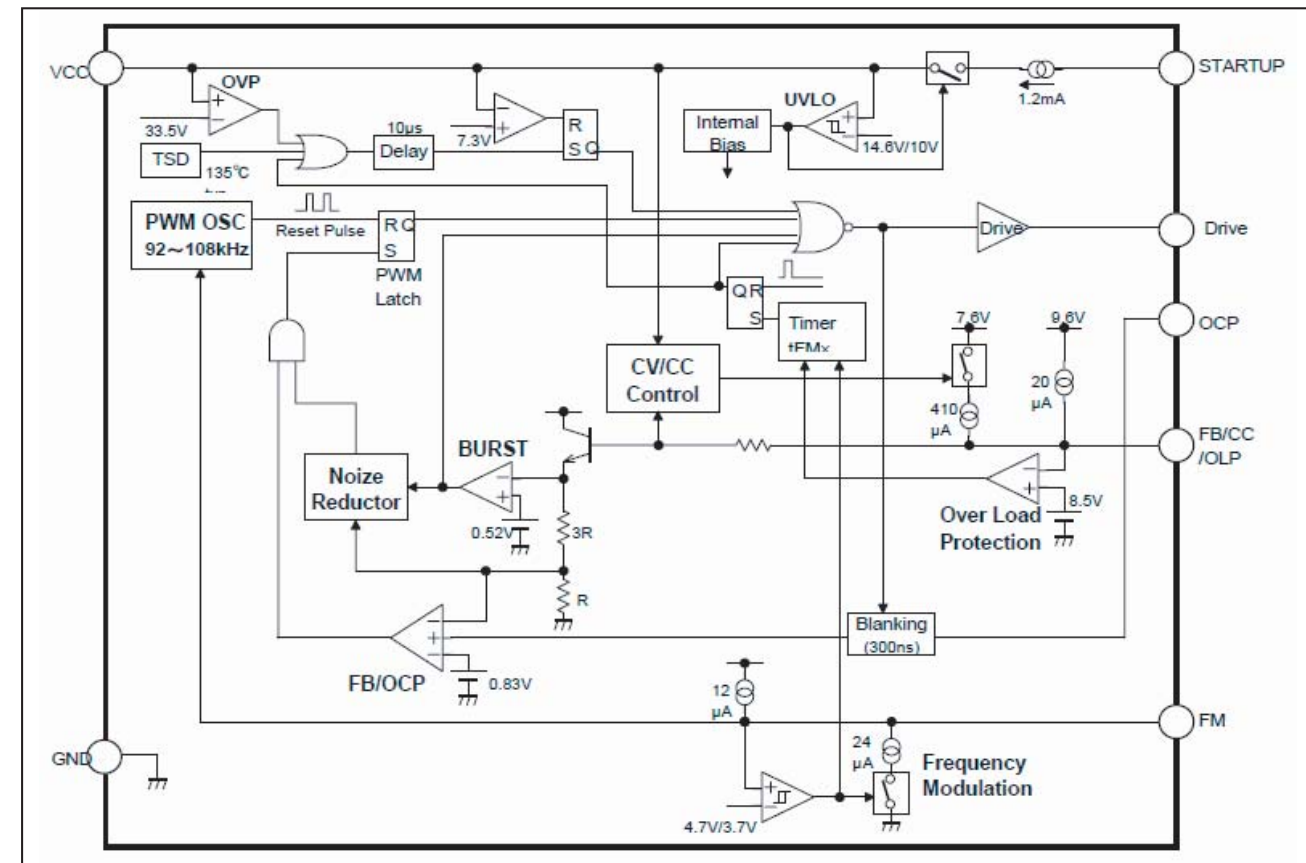

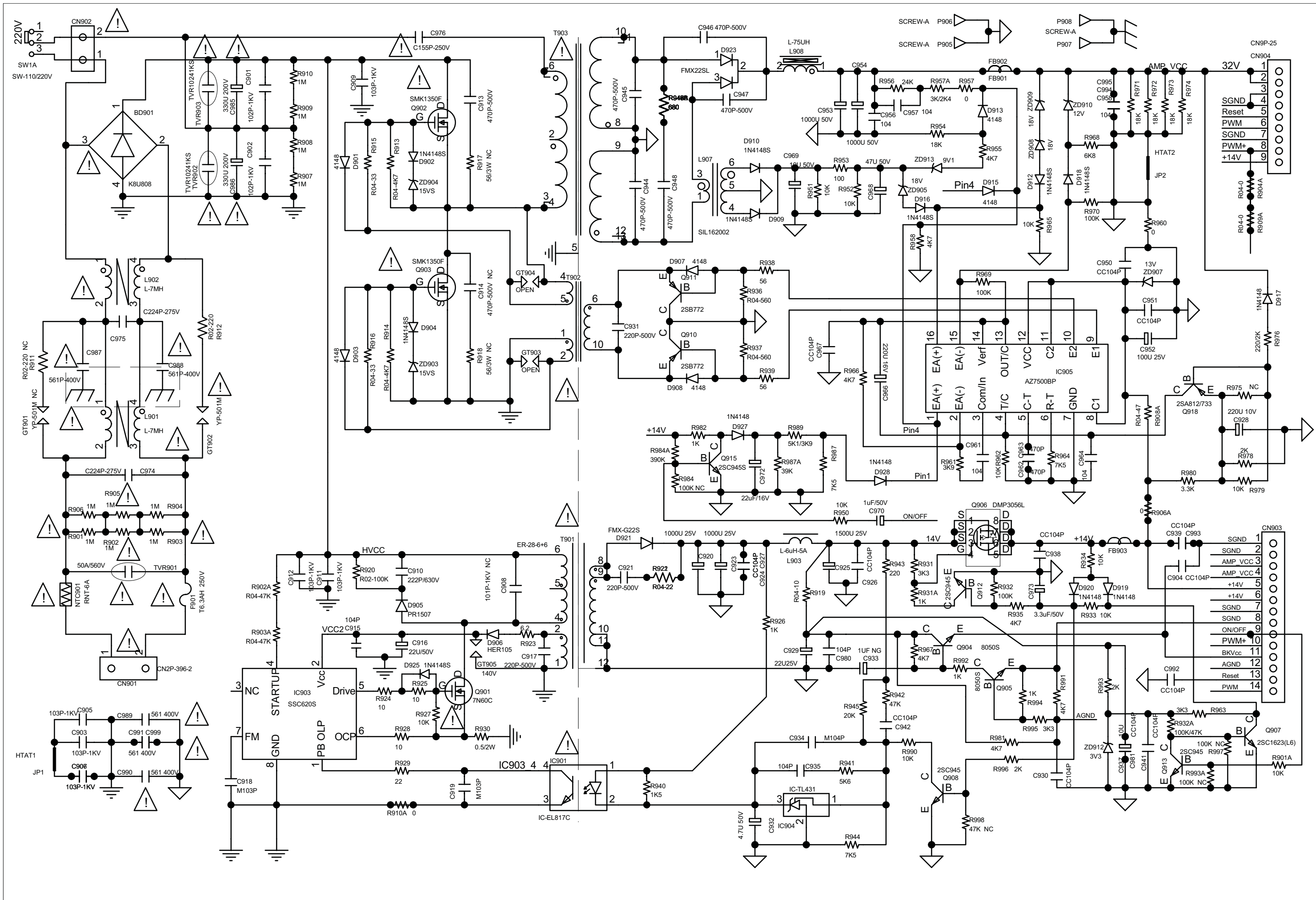

WARNING: FOR CONTINUED PROTECTION AGAINST RISK OF FIRE REPLACE WITH SAME TYPE FUSE.

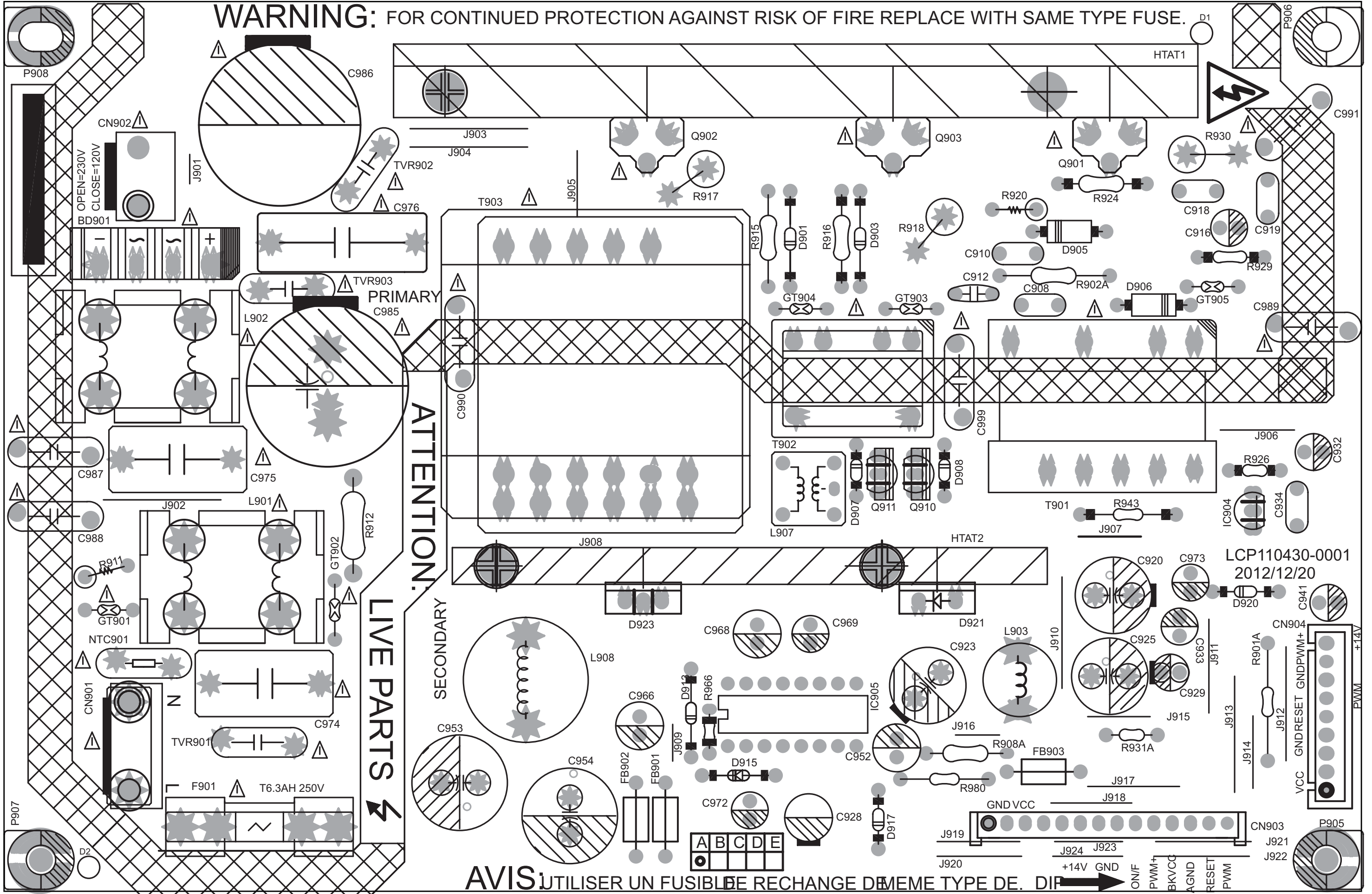

AVIS: UTILISER UN FUSIBLE RECHANGE DE MEME TYPE DE. DIP

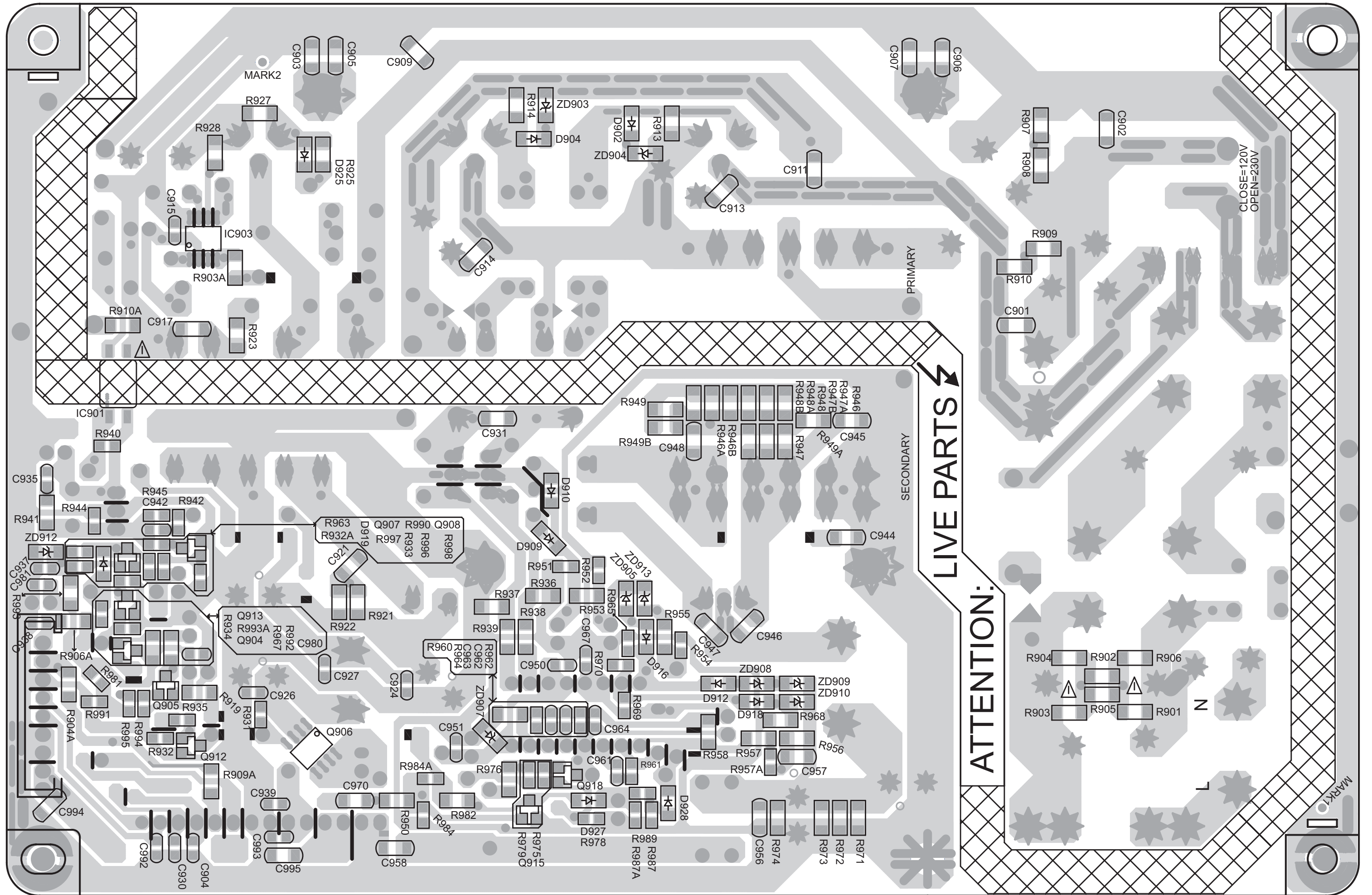

10 - 1
Mechanical Exploded View(Main Unit)

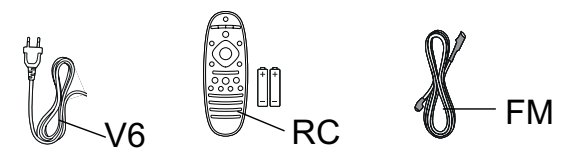
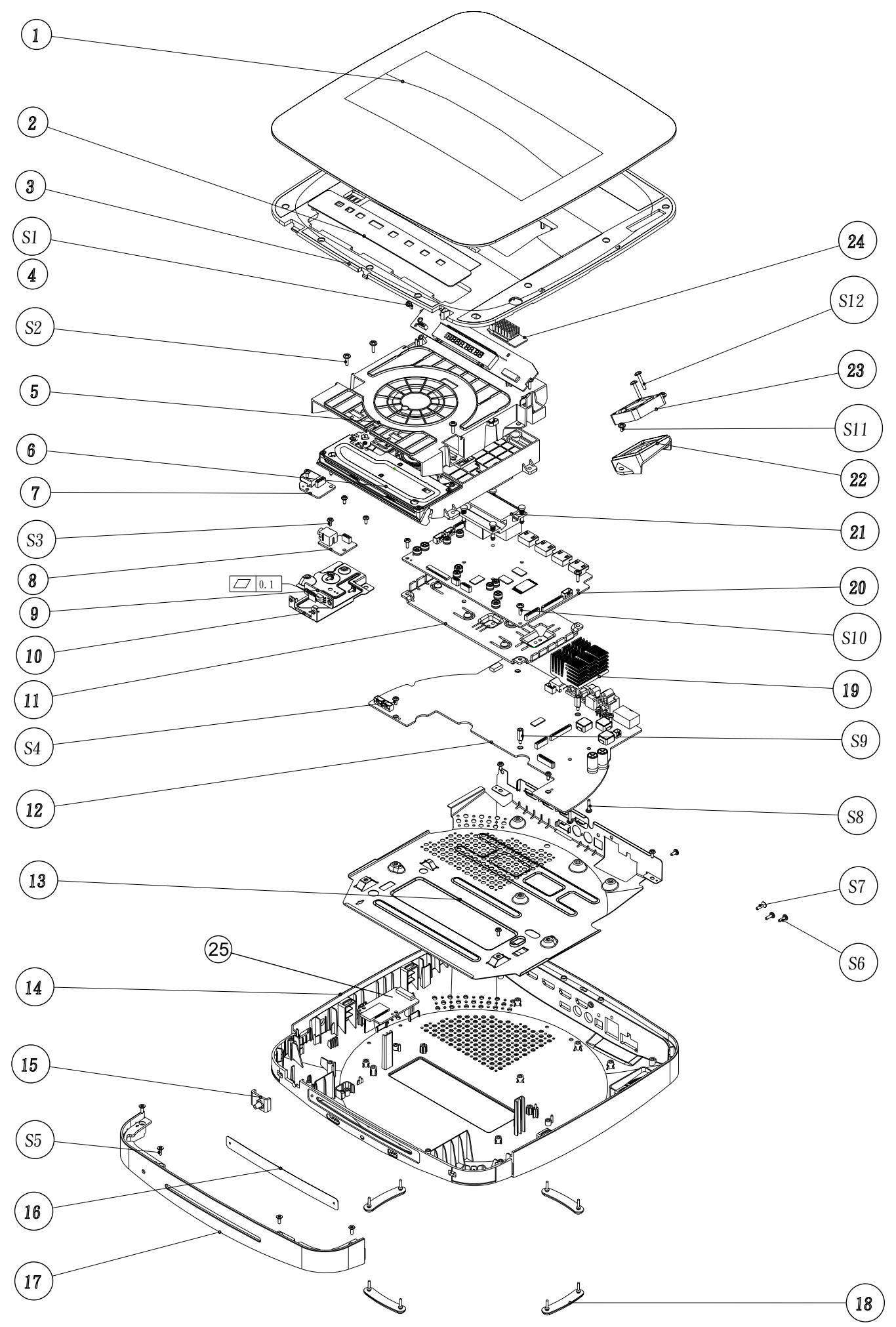

Note: A1=12+4+7+8+9+25+SW2

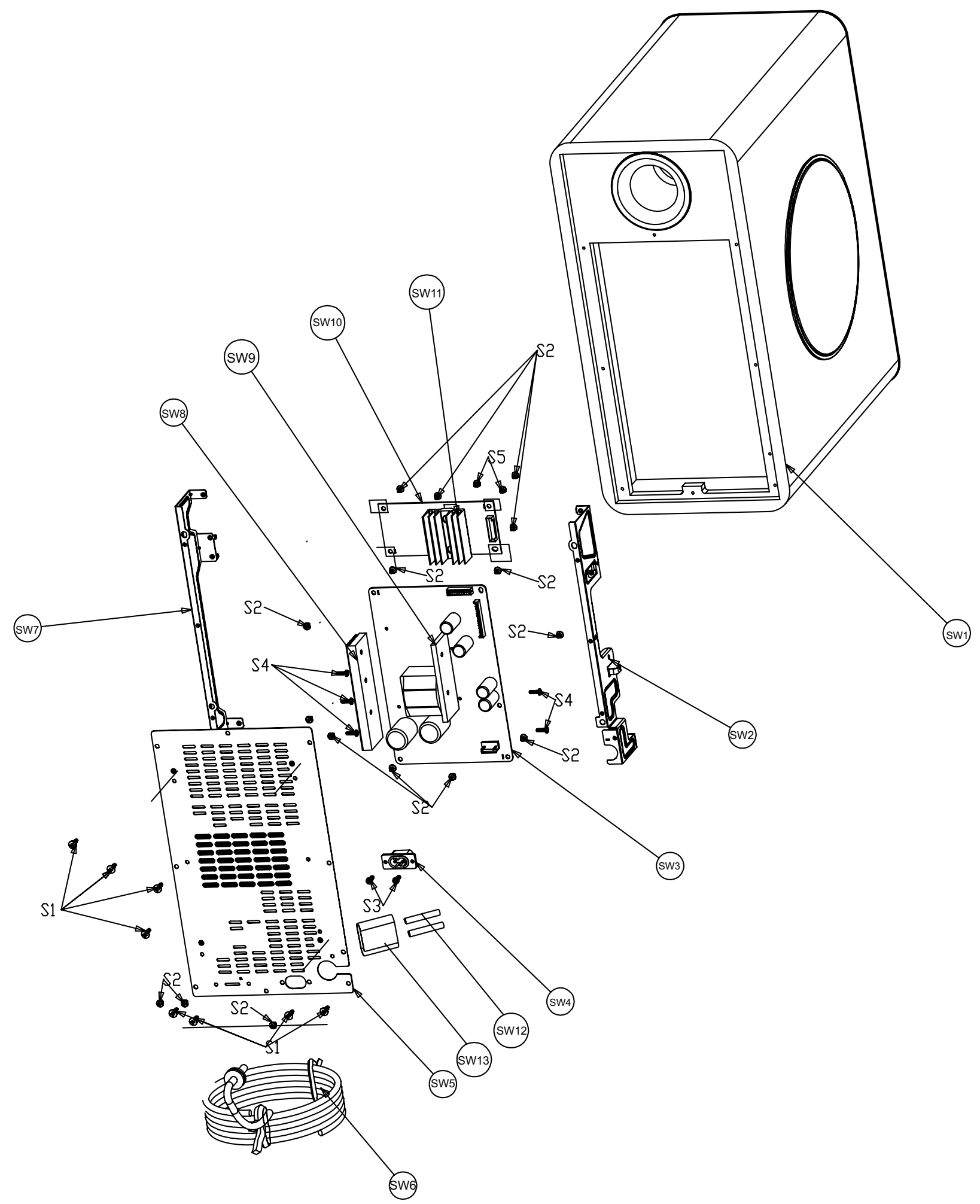

REVISION LIST

Version 1.0

*Initial release

Version 1.1

*Add HTB7255D/12 version